

Manual de montagem

**Linha Completa
Kit Box**

para vidros de 6 e 8mm

FEVEREIRO ■ 2020 - ESTE MANUAL SUBSTITUI TODOS OS ANTERIORES

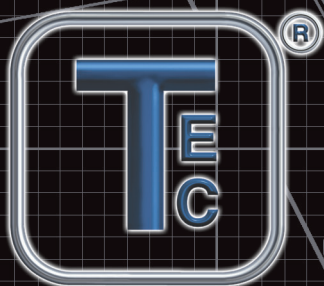

Tec-Vidro

ATENÇÃO:

- AS **MEDIDAS DE FOLGA** E OS **DESENHOS** DESTE **MANUAL** SÃO PARA REFERÊNCIA DE MONTAGEM E PODEM SOFRER MODIFICAÇÕES.
- CONSULTE SEMPRE O **SITE** PARA VERIFICAR AS **ATUALIZAÇÕES**.
- OBSERVAR **DIMENSÕES MÁXIMAS** DE VIDRO RECOMENDADAS PARA CADA MODELO.
- ESTE **MANUAL** **SUBSTITUI** TODAS AS VERSÕES ANTERIORES.

IMPORTANTE:

- FAZER A INSTALAÇÃO OBSERVANDO "NÍVEL" E "PRUMO" EXATOS EVITANDO TORÇÕES E DESALINHAMENTOS QUE VENHAM A COMPROMETER O PERFEITO FUNCIONAMENTO (SE POSSÍVEL, UTILIZAR INSTRUMENTOS DE **MEDIÇÃO DE PRECISÃO**)
- A MONTAGEM DEVE SER EFETUADA POR UM **PROFISSIONAL QUALIFICADO** COM EXPERIÊNCIA EM INSTALAÇÕES COM **VIDRO TEMPERADO**

ÍNDICE

APRESENTAÇÃO

4

MEDIDAS P/ VIDROS 6/8MM

6

FERRAMENTAS

8

KIT BOX FRONTAL

F1/MF1

9

1 FIXO E 1 PORTA

KIT BOX FRONTAL

F2/MF2

21

2 FIXOS E 1 PORTA

KIT BOX FRONTAL

F3/MF3

33

2 FIXOS E 2 PORTAS

KIT BOX DE CANTO

C1/Mc1

45

2 FIXOS E 2 PORTAS

KIT BOX DE ABRIR

AF

57

SEM TRANSPACE

KIT BOX DE ABRIR

AF

65

COM TRANSPACE

3

APRESENTAÇÃO

ESTE MANUAL DE MONTAGEM DESTINA-SE AOS MODELOS:

R6

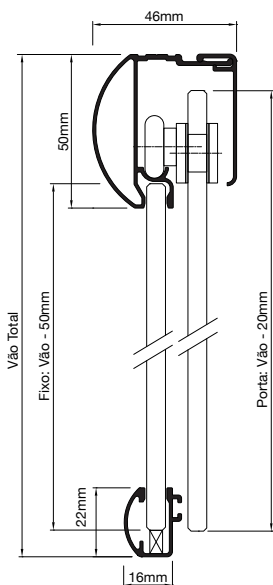

R8

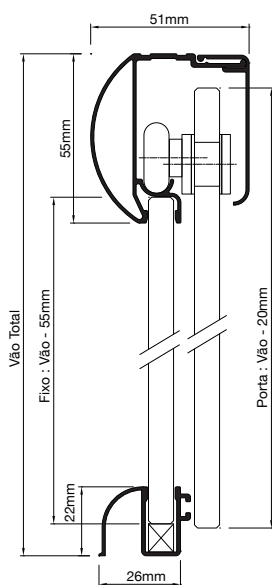

MULTIBOX

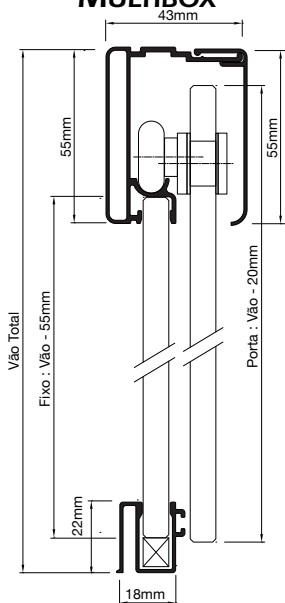

APRESENTAÇÃO

DUAS PORTAS

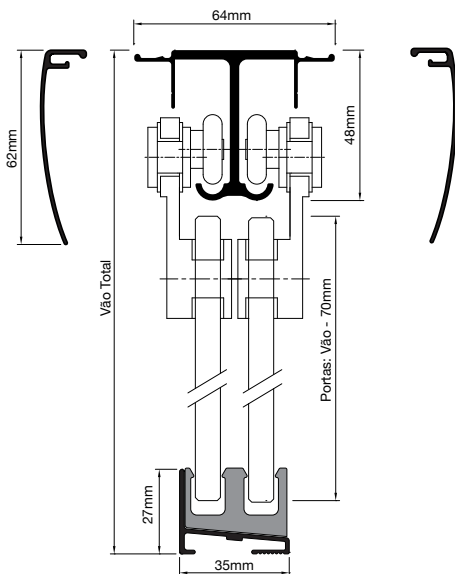

BOX DE ABRIR

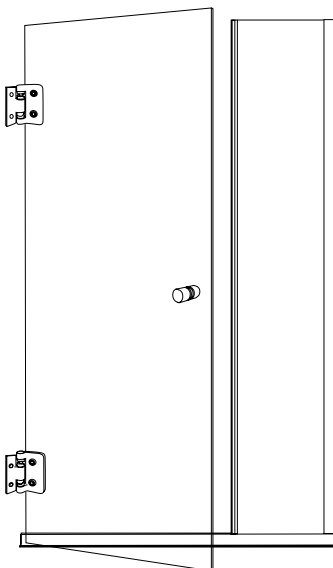

VIDROS DE 6MM

FURAÇÃO PARA ROLDANAS

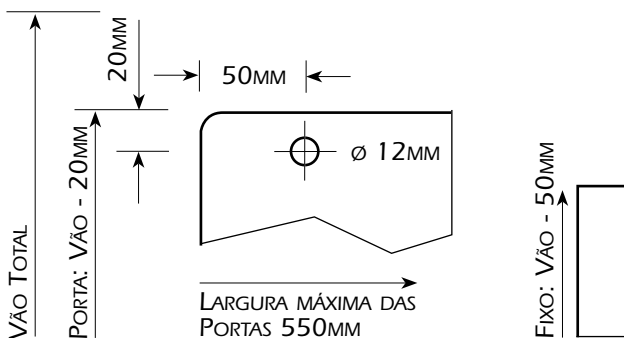

FURAÇÃO PARA PUXADOR

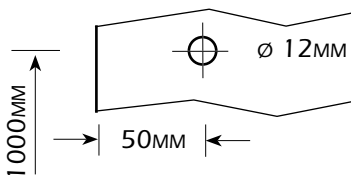

PERFIL GUIA

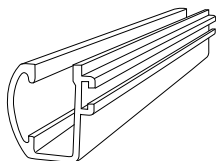

R6

VIDROS DE 8MM

FURAÇÃO PARA ROLDANAS

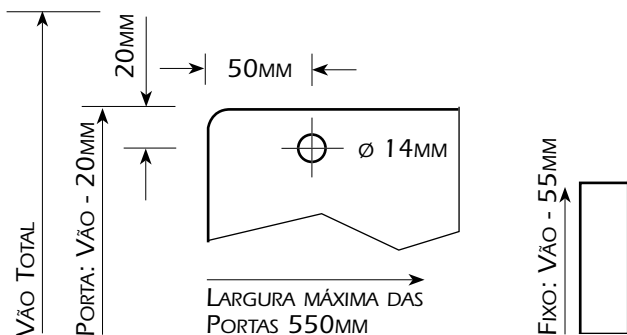

FURAÇÃO PARA PUXADOR

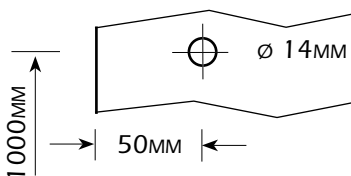

PERFIL GUIA

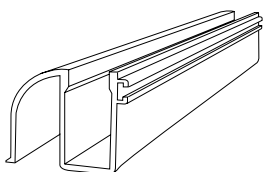

R8

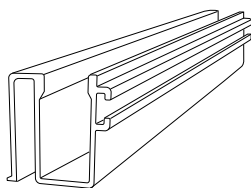

MULTIBOX

FERRAMENTAS

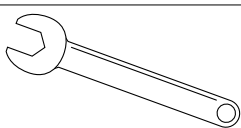

CHAVE FIXA 19MM

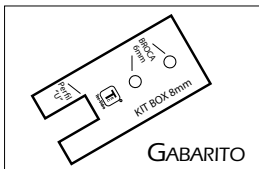

GABARITO

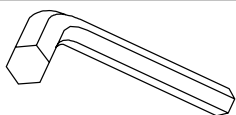

CHAVE ALLEN 4MM

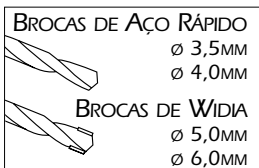

BROCAS DE AÇO RÁPIDO

Ø 3,5MM

Ø 4,0MM

BROCAS DE WIDIA

Ø 5,0MM

Ø 6,0MM

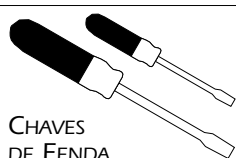

CHAVES
DE FENDA

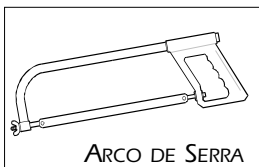

ARCO DE SERRA

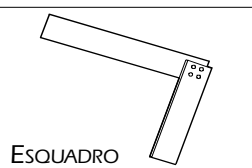

ESQUADRO

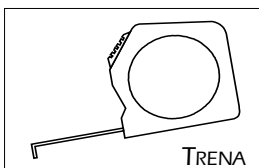

TRENA

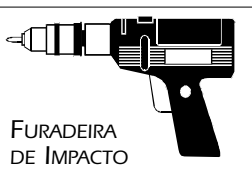

FURADEIRA
DE IMPACTO

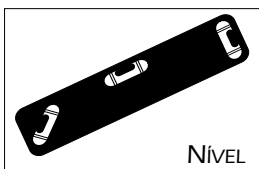

NÍVEL

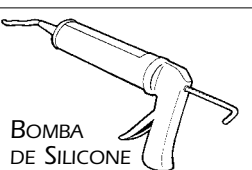

BOMBA
DE SILICONE

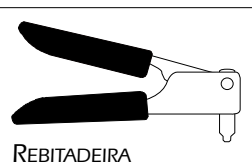

REBITADEIRA

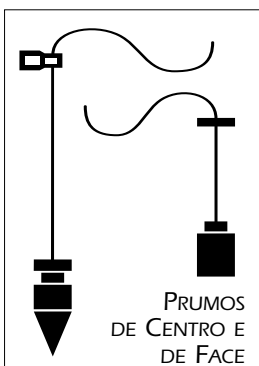

PRUMOS
DE CENTRO E
DE FACE











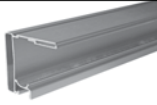

1 FIXO E 1 PORTA

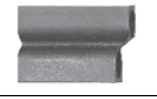

F1/MF1

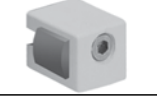

IMAGEM ILUSTRATIVA



ITEM	QUANT.	DESCRIÇÃO	DESENHO
A	01	PERFIL TRILHO	
B	01	PERFIL CAPA	
C	01	PERFIL GUIA	
D	01	PERFIL ARREMATE	
E	01	PERFIL "U" 20x10	
F	01	PERFIL "U" 20x15	
G	02	SUPORE FIXAÇÃO TRILHO	
H	02	CUNHA TRAVA DO SUPORTE	
I	01	CONJUNTO BATEDEIRA INFERIOR	
J	01	GUIA NYLON	
K	01	BATEDEIRA SUPERIOR	
L	02	BATEDEIRA AMORTECEDORA	
M	01	PUXADOR	

ITEM	QUANT.	DESCRIÇÃO	DESENHO
N	06	REBITE "POP"	
O	02	ROLDANA	
P	04	PARAFUSO CABEÇA PANELA Ø 3,9x32MM	
Q	04	BUCHA 6MM	
R	04	PARAFUSO CABEÇA CHATA Ø 3,5x22MM	
S	04	BUCHA 5MM	
T	02	CUNHA REGULAGEM	
U	02	ARREIMATE DO TRILHO	
V	01	ESCOVA DE VEDAÇÃO	

OBS.: OS ELEMENTOS DE FIXAÇÃO (P, Q, R E S)
SÃO PARA USO EM ALVENARIA

AS IMAGENS DE CONTEÚDO PODEM SOFRER ALTERAÇÕES DE
DESENHO CONFORME MODELO UTILIZADO

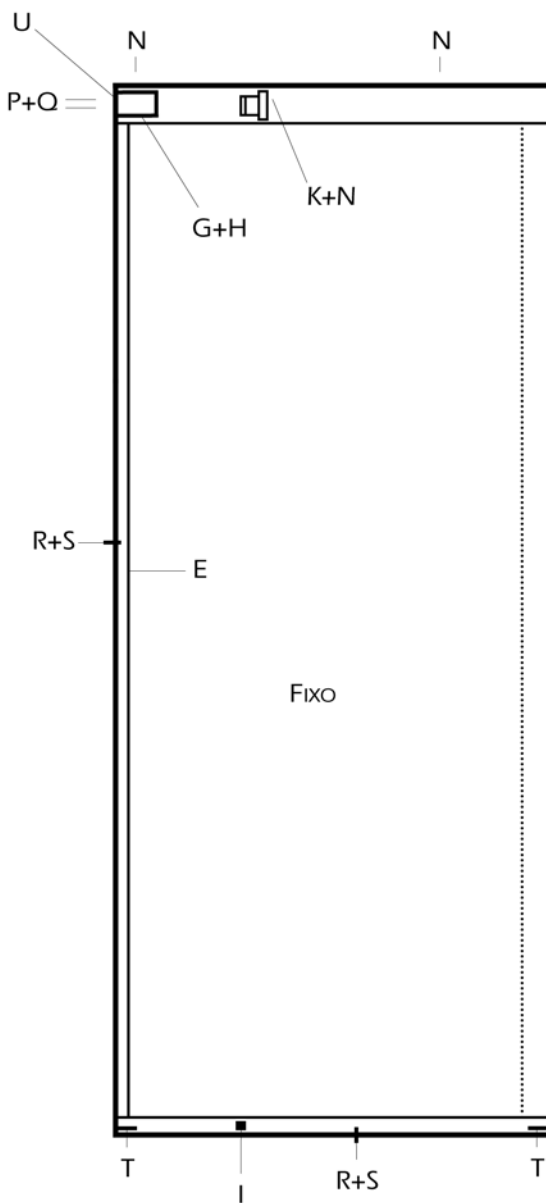

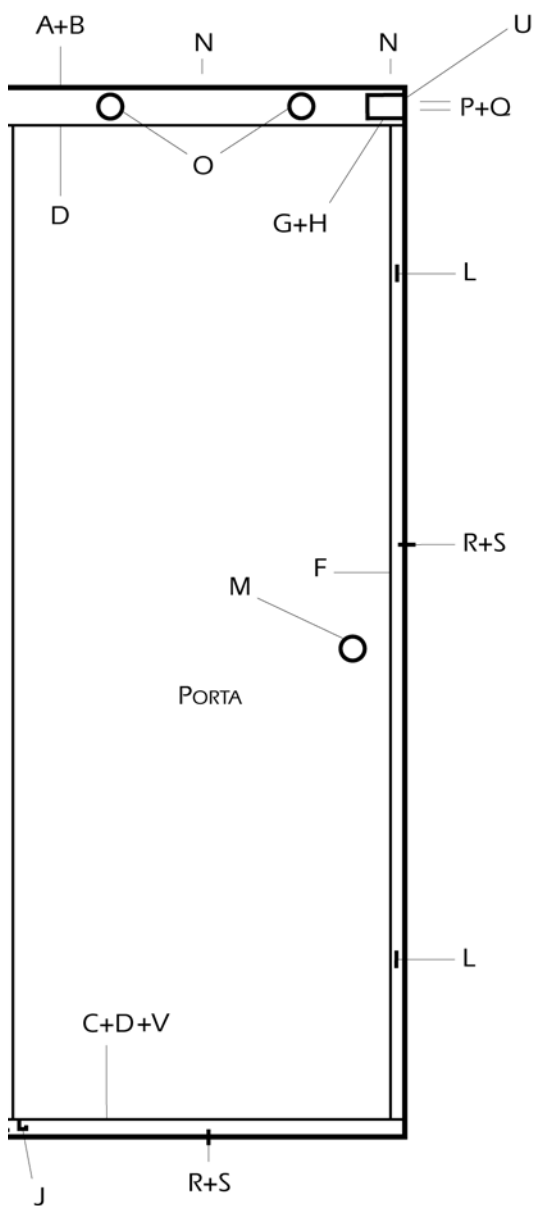

01 MONTAR PERFIL GUIA (C)

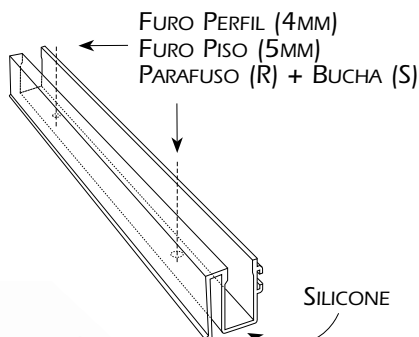

02 MARCAR OS FUROS DO SUPORTE DO TRILHO (G) USANDO O PERFIL "U" 20x10MM (E)

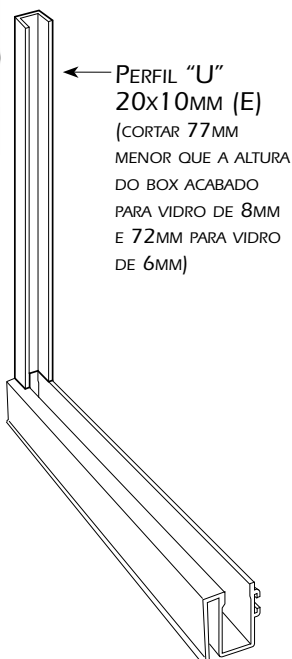
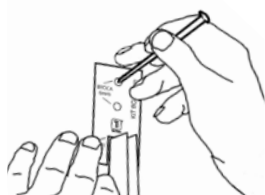

SILICONE

03 FIXAR PERFIL "U" 20x10MM (E) COM BUCHA (S) + PARAFUSO (R)

FURO PERFIL (4MM)
FURO PAREDE (5MM)



04 FIXAR OS SUPORTES DO TRILHO (G)

FURO PAREDE (6MM)
PARAFUSO (P) + BUCHA (Q)

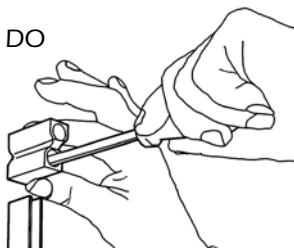

05 CORTAR O PERFIL TRILHO (A) 4MM MENOR QUE O VÃO E ENCAIXAR OS ARREMATES (U) NAS EXTREMIDADES

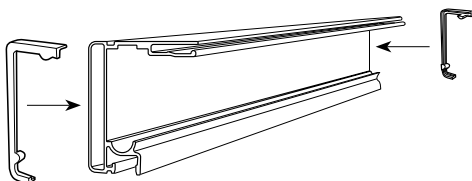

06 ENCAIXAR O CONJUNTO PERFIL TRILHO (A) E ARREMATES (U) NOS SUPORTES DOS TRILHOS (G)

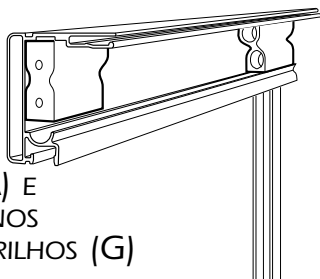

FUROS P/ REBITE (N) (3.5MM)

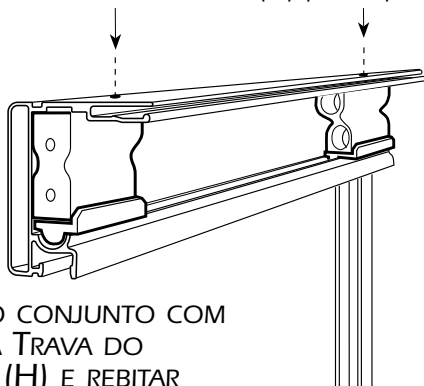

07 TRAVAR O CONJUNTO COM A CUNHA TRAVA DO SUPORTE (H) E REBITAR

- 08** TRAVAR O VIDRO FIXO COM A CUNHA DE REGULAGEM (T)

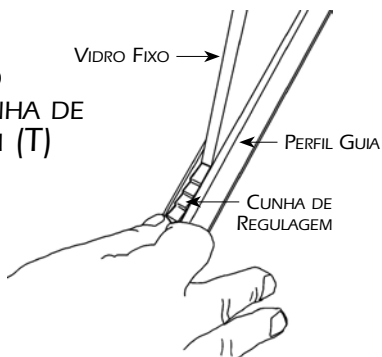

- 09** VERIFICAR O NIVELAMENTO DO CONJUNTO

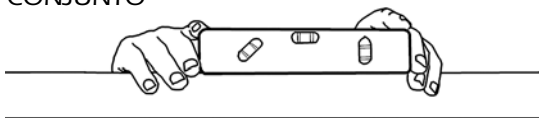

- 10** COLOCAR A GUIA DE NYLON (J) NO PERFIL GUIA (C)

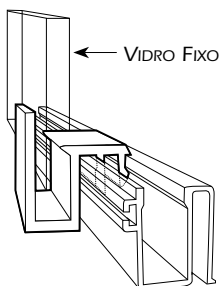
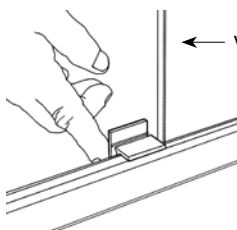

- 11** MONTAR AS ROLDANAS (O) E O PUXADOR (M) NA PORTA

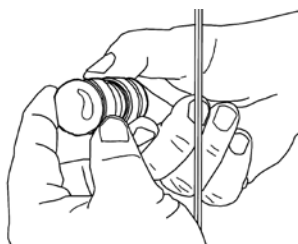
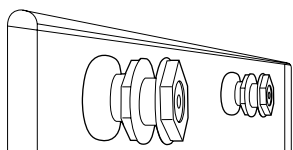

- 12** COLOCAR A PORTA MONTADA NO PERFIL TRILHO (A) E NA GUIA DE NYLON (J)

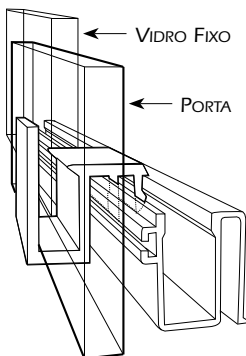

- 13** REGULAR A PORTA

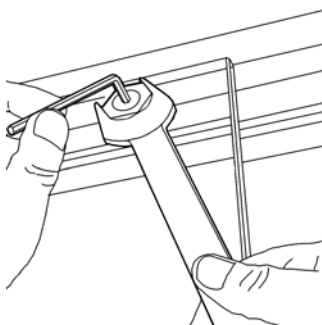

- 14** INSTALAR O PERFIL "U" 20x15 (F) COM BUCHA (S) + PARAFUSO (R)

FURO PERFIL (4MM)
FURO PAREDE (5MM)

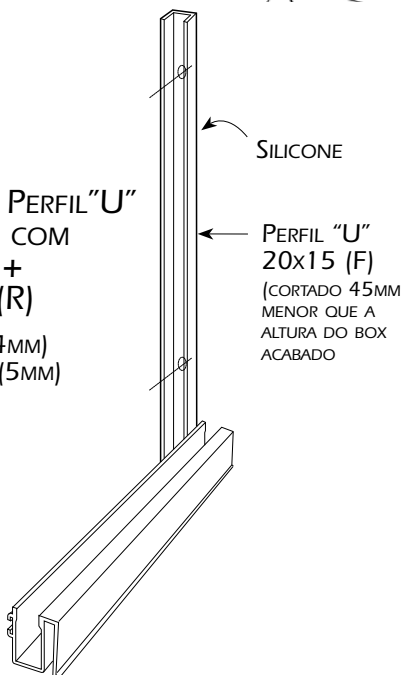

- 15 DETERMINAR A POSIÇÃO DE PARADA DA PORTA E FIXAR A BATEDEIRA LIMITADORA SUPERIOR (K) E INFERIOR (I)

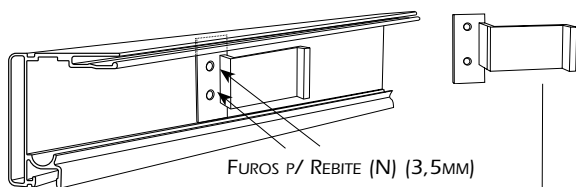

BATEDEIRA SUPERIOR (K)

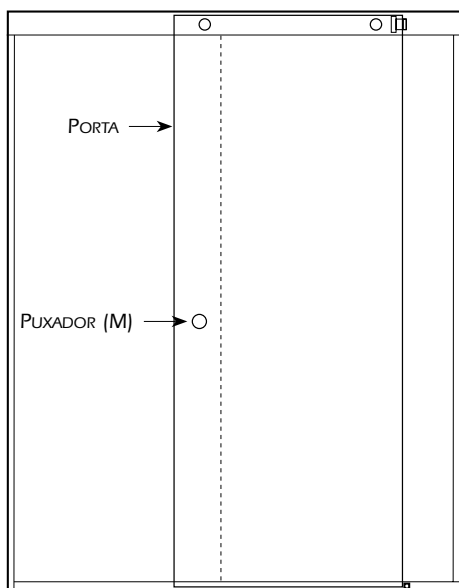

CONJUNTO BATEDEIRA INFERIOR (I)

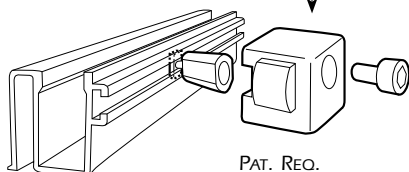

- 16 DETERMINAR AS MEDIDAS, CORTAR E ENCAIXAR OS PERFIS ARREMATE (D) NOS CANAIS DOS PERFIS TRILHO (A) E GUIA (C). ENCAIXAR A ESCOVA DE VEDAÇÃO (V) NO PERFIL GUIA (C)

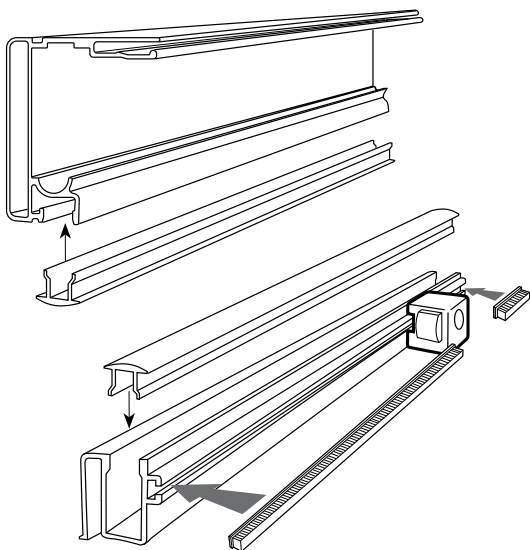

- 17 DETERMINAR AS MEDIDAS, CORTAR E ENCAIXAR O PERFIL CAPA (B) NO PERFIL TRILHO (A) E REBITAR

FUROS P/ REBITE (N) (3,5MM)

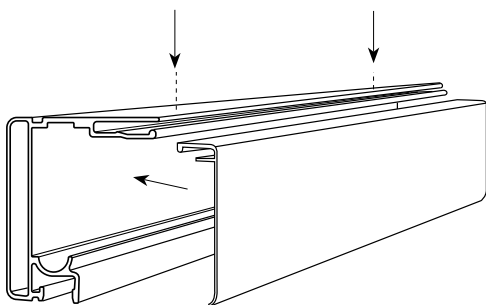

IMPORTANTE: PARA GARANTIR A SEGURANÇA DO PRODUTO INSTALADO, É OBRIGATÓRIO A REBITAGEM DA CAPA!

- 18 VEDAR TODA A PERIFERIA INTERNA
ENTRE PERFIS E AZULEJO.
UTILIZAR SILICONE
ANTIFUNGO

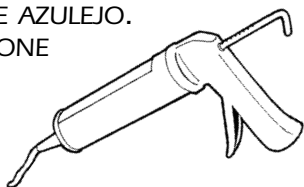

2 FIXOS E 1 PORTA







F2/MF2



IMAGEM ILUSTRATIVA



ITEM	QUANT.	DESCRIÇÃO	DESENHO
A	01	PERFIL TRILHO	
B	01	PERFIL CAPA	
C	01	PERFIL GUIA	
D	01	PERFIL ARREIMATE	
E	02	PERFIL "U" 20x10	
F	02	SUPORE FIXAÇÃO TRILHO	
G	02	CUNHA TRAVA DO SUPORE	
H	02	CONJUNTO BATEDEIRA INFERIOR	
I	01	GUIA NYLON	
J	02	BATEDEIRA SUPERIOR	
K	01	PUXADOR	
L	08	REBITE "POP"	
M	02	ROLDANA	

ITEM	QUANT.	DESCRIÇÃO	DESENHO
N	04	PARAFUSO CABEÇA PANELA Ø 3,9x32MM	
O	04	BUCHA 6MM	
P	04	PARAFUSO CABEÇA CHATA Ø 3,5x22MM	
Q	04	BUCHA 5MM	
R	04	CUNHA REGULAGEM	
S	02	ARREIMATE DO TRILHO	
T	01	ESCOVA DE VEDAÇÃO	

Obs.: OS ELEMENTOS DE FIXAÇÃO (N, O, P E Q)
SÃO PARA USO EM ALVENARIA

AS IMAGENS DE CONTEÚDO PODEM SOFRER ALTERAÇÕES
DE DESENHO CONFORME MODELO UTILIZADO

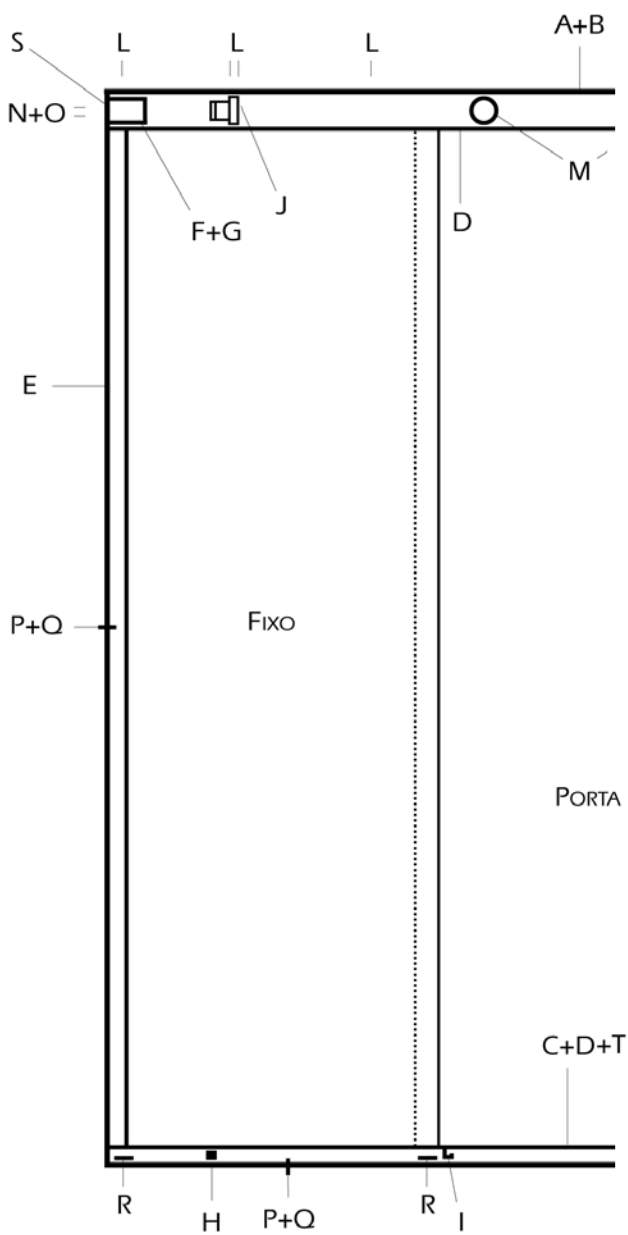

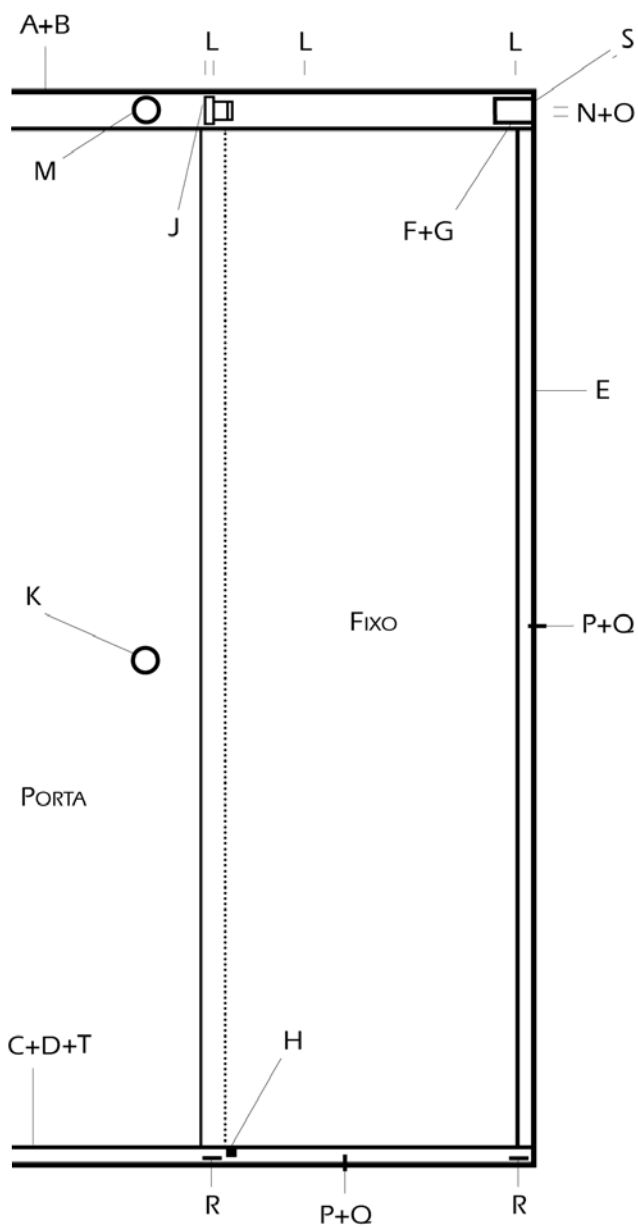

01 MONTAR PERFIL GUIA (C)

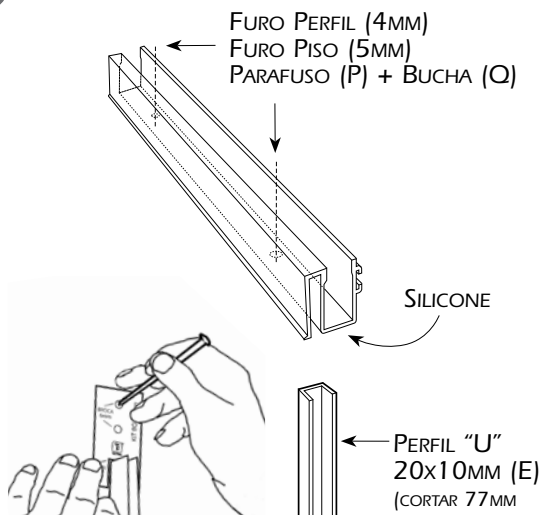

02 MARCAR OS FUROS DO SUPORTE DO TRILHO (F) USANDO O PERFIL "U" 20x10MM (E)



03 FIXAR OS PERFIS "U" 20x10MM (E) COM BUCHA (Q) + PARAFUSO (R)

FURO PERFIL (4MM)
FURO PAREDE (5MM)

04 FIXAR OS SUPORTES DO TRILHO (F)

FURO PAREDE (6MM)
PARAFUSO (N) + BUCHA (O)

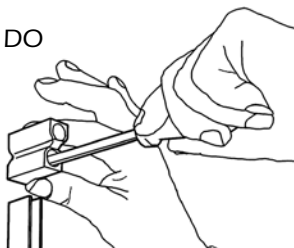

05 CORTAR O PERFIL TRILHO (A) 4MM MENOR QUE O VÃO E ENCAIXAR OS ARREMATES (S) NAS EXTREMIDADES

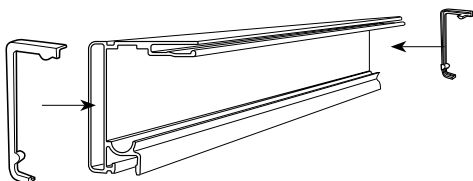

06 ENCAIXAR O CONJUNTO PERFIL TRILHO (A) E ARREMATES (S) NOS SUPORTES DOS TRILHOS (F)

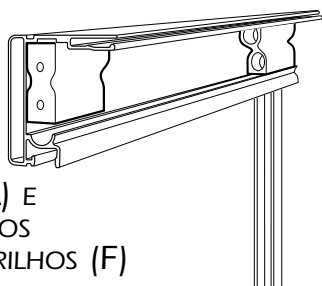

FUROS P/ REBITE (L) (3,5MM)

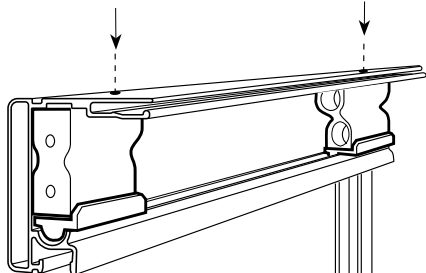

07 TRAVAR O CONJUNTO COM A CUNHA TRAVA DO SUPORTE (G) E REBITAR

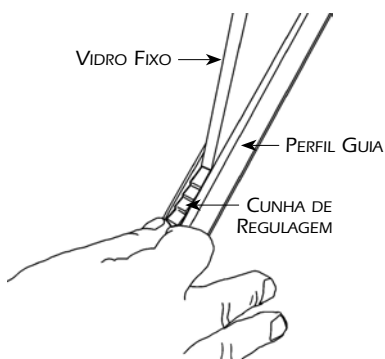
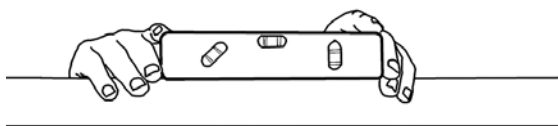
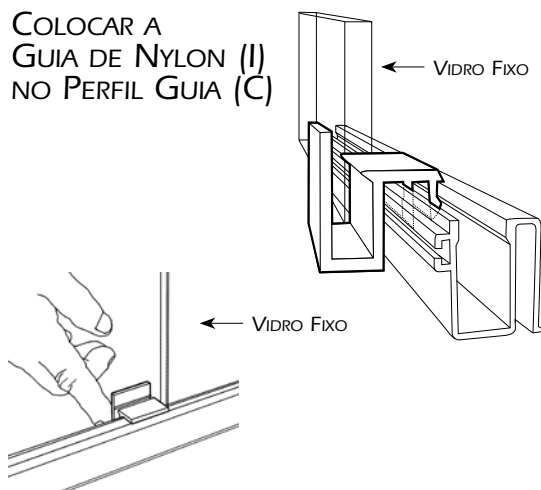
08 TRAVAR OS VIDROS FIXOS COM AS CUNHAS DE REGULAGEM (R)**09** VERIFICAR O NIVELAMENTO DO CONJUNTO**10** COLOCAR A GUIA DE NYLON (II) NO PERFIL GUIA (C)

- 11** MONTAR AS ROLDANAS (M) E O PUXADOR (K) NA PORTA

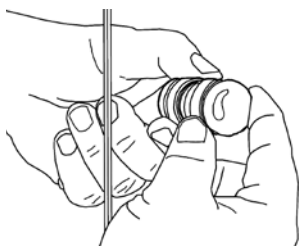
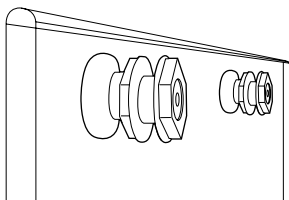

- 12** COLOCAR A PORTA MONTADA NO PERFIL TRILHO (A) E NA GUIA DE NYLON (I)

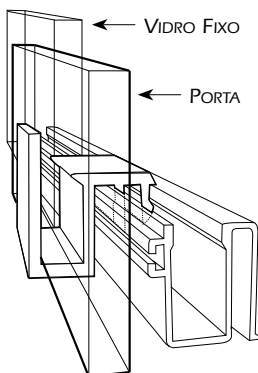

- 13** REGULAR A PORTA

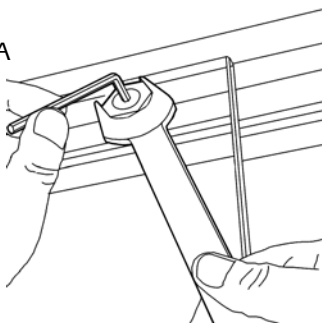

- 14 DETERMINAR A POSIÇÃO DE PARADA DA PORTA E FIXAR A BATEDEIRA LIMITADORA SUPERIOR (J) E INFERIOR (H)

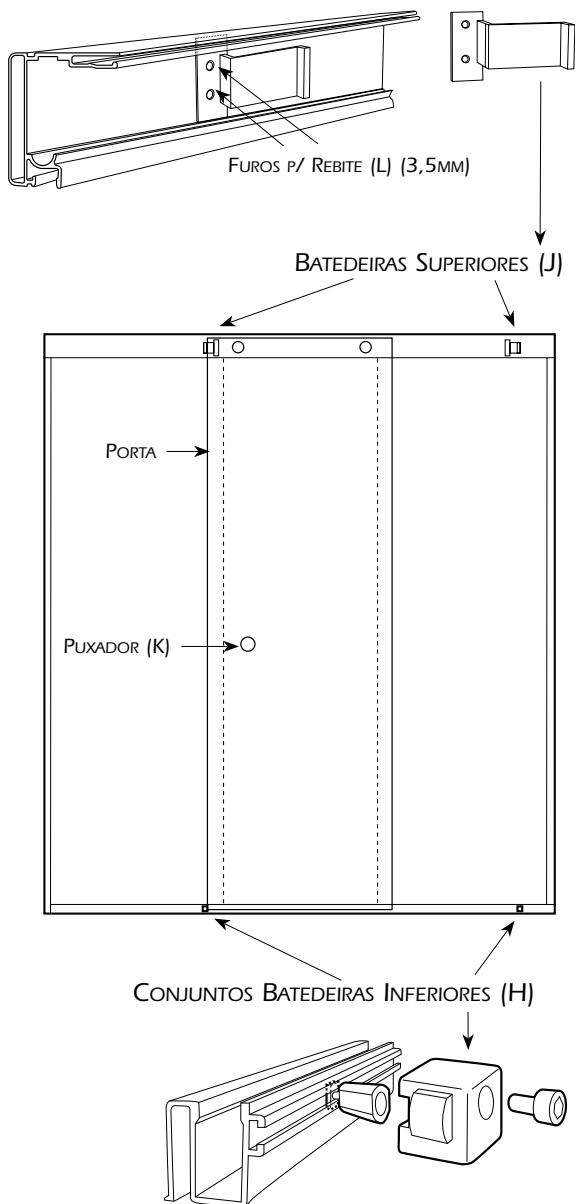

- 15 DETERMINAR AS MEDIDAS, CORTAR E ENCAIXAR OS PERFIS ARREMATE (D) NOS CANAIS DOS PERFIS TRILHO (A) E GUIA (C). ENCAIXAR A ESCOVA DE VEDAÇÃO (T) NO PERFIL GUIA (C)

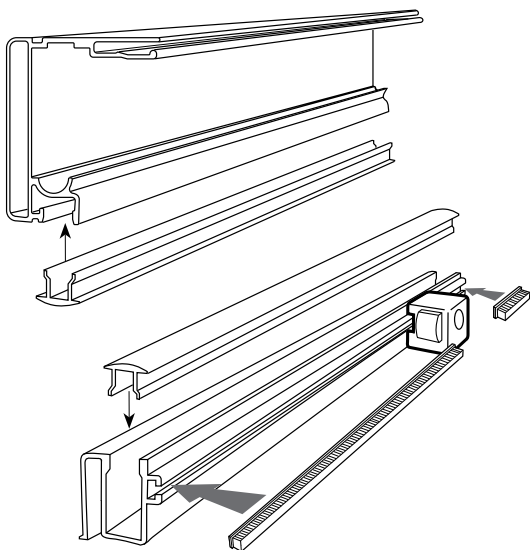

- 16 DETERMINAR AS MEDIDAS, CORTAR E ENCAIXAR O PERFIL CAPA (B) NO PERFIL TRILHO (A) E REBITAR

FUROS P/ REBITE (N) (3,5MM)

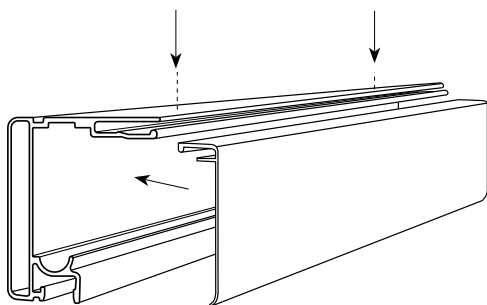

IMPORTANTE: PARA GARANTIR A SEGURANÇA DO PRODUTO INSTALADO, É OBRIGATÓRIO A REBITAGEM DA CAPA!

- 17 VEDAR TODA A PERIFERIA INTERNA ENTRE
PERFIS E AZULEJO.
UTILIZAR SILICONE
ANTIFUNGO

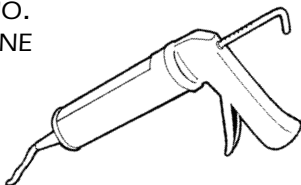

2 FIXOS E 2 PORTAS

F3/MF3



IMAGEM ILUSTRATIVA



ITEM	QUANT.	DESCRIÇÃO	DESENHO
A	01	PERFIL TRILHO	
B	01	PERFIL CAPA	
C	01	PERFIL GUIA	
D	01	PERFIL ARREMATE	
E	02	PERFIL "U" 20x10	
F	01	PERFIL "H" VEDAÇÃO	
G	01	ESCOVA DE VEDAÇÃO	
H	02	SUORTE FIXAÇÃO TRILHO	
I	02	CUNHA TRAVA DO SUORTE	
J	02	BATEDEIRA SUPERIOR LATERAL	
J1	02	BATEDEIRA SUPERIOR CENTRAL	
K	02	PUXADOR	
L	02	CONJUNTO BATEDEIRA INFERIOR	

ITEM	QUANT.	DESCRIÇÃO	DESENHO
M	12	REBITE "POP"	
N	04	ROLDANA	
O	04	PARAFUSO CABEÇA PAINELA Ø 3,9x32MM	
P	04	BUCHA 6MM	
Q	04	PARAFUSO CABEÇA CHATA Ø 3,5x22MM	
R	04	BUCHA 5MM	
S	02	GUIA NYLON	
T	04	CUNHA REGULAGEM	
U	02	ARREIMATE DO TRILHO	

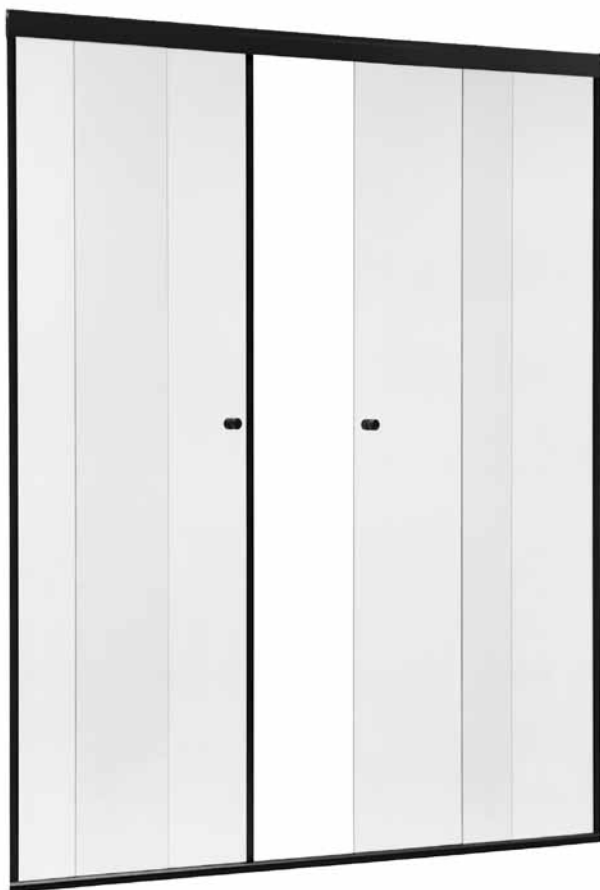
OBS.: OS ELEMENTOS DE FIXAÇÃO (O, P, Q E R)
SÃO PARA USO EM ALVENARIA

AS IMAGENS DE CONTEÚDO PODEM SOFRER ALTERAÇÕES
DE DESENHO CONFORME MODELO UTILIZADO

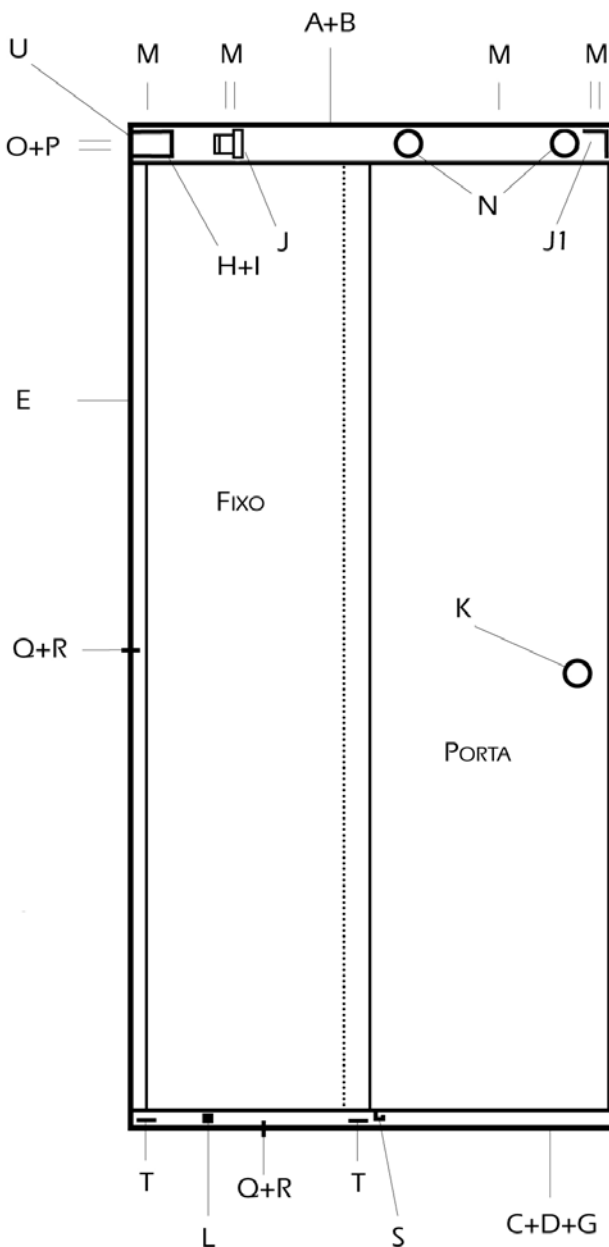

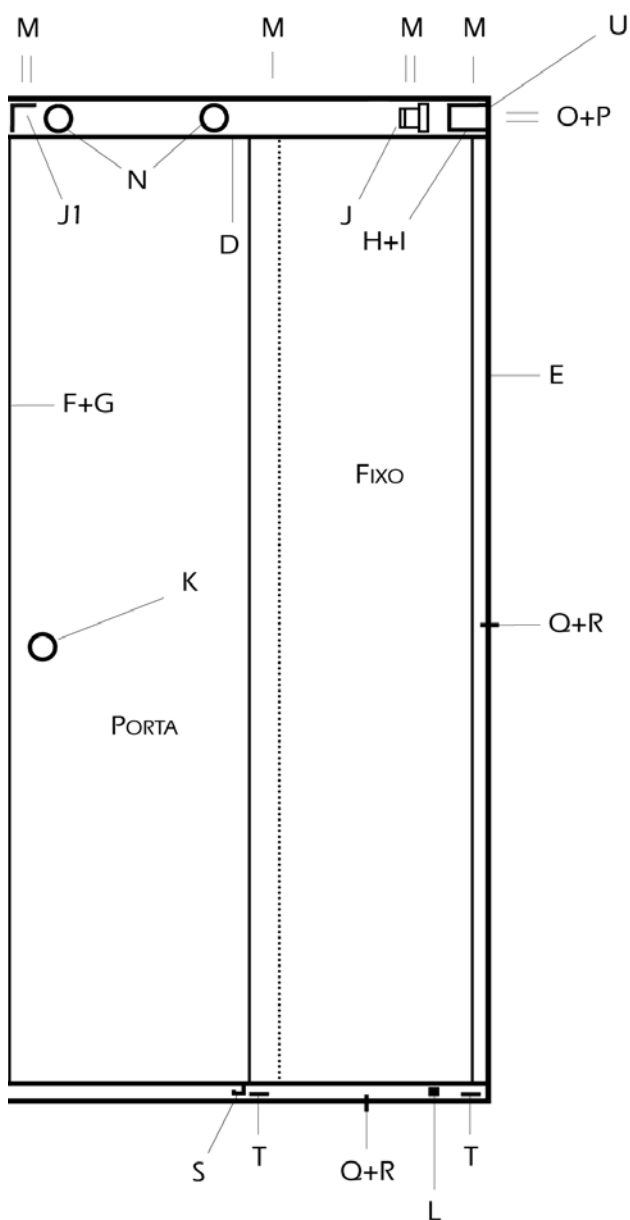

01 MONTAR PERFIL GUIA (C)

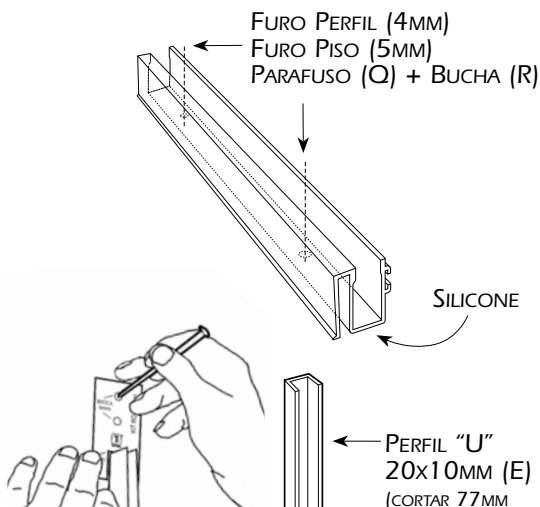

02 MARCAR OS FUROS DO SUPORTE DO TRILHO (H) USANDO O PERFIL "U" 20X10MM (E)

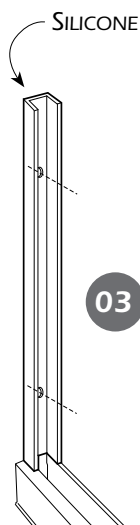

03 FIXAR OS PERFIS "U" 20X10MM (E) COM BUCHA (Q) + PARAFUSO (R)

FURO PERFIL (4MM)
FURO PAREDE (5MM)

- 04** FIXAR OS SUPORTES DO TRILHO (H)

FURO PAREDE (6MM)
PARAFUSO (O) + BUCHA (P)

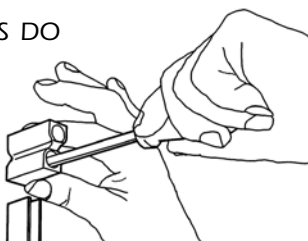

- 05** CORTAR O PERFIL TRILHO (A) 4MM MENOR QUE O VÃO E ENCAIXAR OS ARREMATES (U) NAS EXTREMIDADES

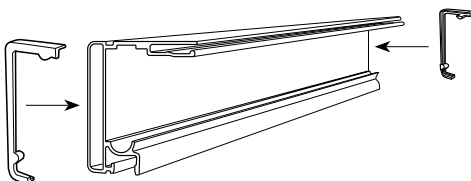

- 06** ENCAIXAR O CONJUNTO PERFIL TRILHO (A) E ARREMATES (U) NOS SUPORTES DOS TRILHOS (H)

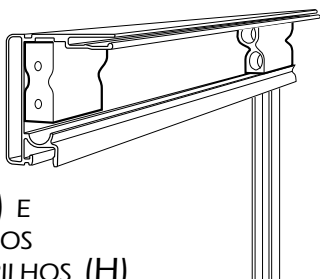

FUROS P/ REBITE (M) (3.5MM)

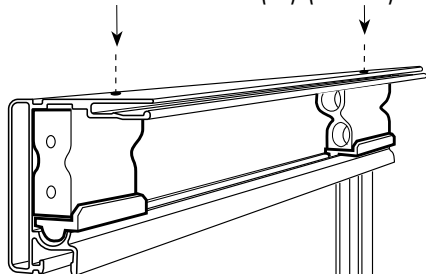

- 07** TRAVAR O CONJUNTO COM A CUNHA TRAVA DO SUPORTE (I) E REBITAR

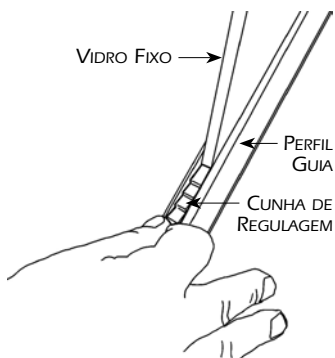
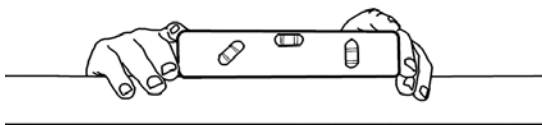
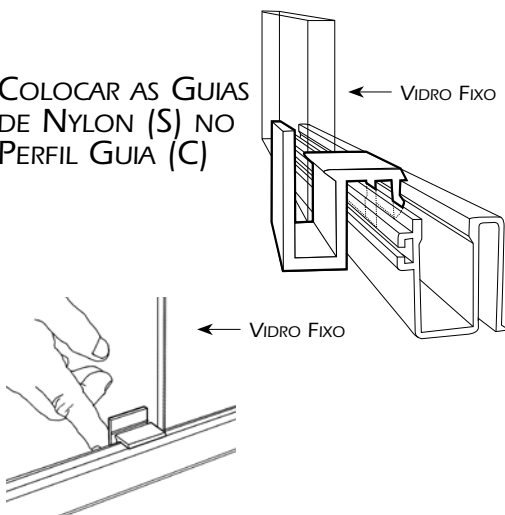
08 TRAVAR OS VIDROS FIXOS COM AS CUNHAS DE REGULAGEM (T)**09** VERIFICAR O NIVELAMENTO DO CONJUNTO**10** COLOCAR AS GUIAS DE NYLON (S) NO PERFIL GUIA (C)

- 11** MONTAR AS ROLDANAS (N) E OS PUXADORES (K) NAS PORTAS

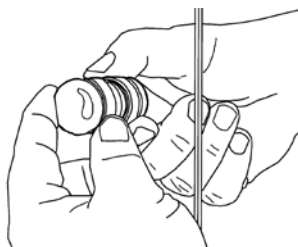
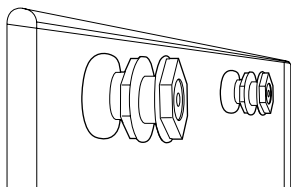

- 12** COLOCAR AS PORTAS MONTADAS NO PERFIL TRILHO (A) E NA GUIA DE NYLON (S)

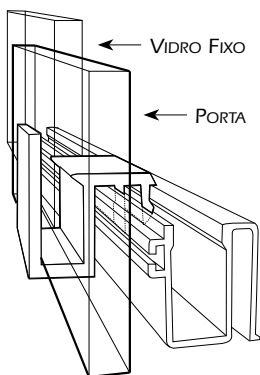

- 13** REGULAR AS PORTAS

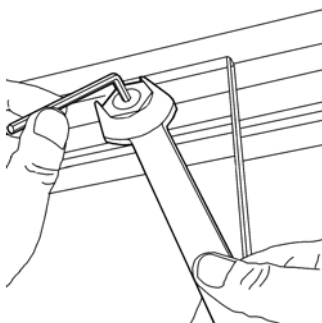

- 14 DETERMINAR A POSIÇÃO DE PARADA DAS PORTAS E FIXAR AS BATEDEIRAS LIMITADORAS SUPERIORES (J E J1) E INFERIORES (L)

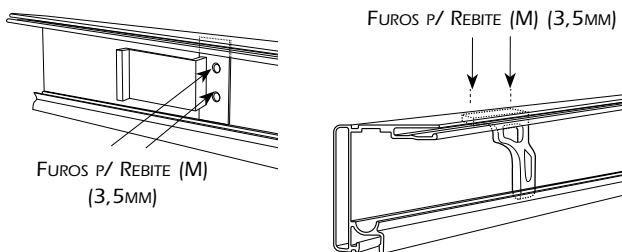

BATEDEIRAS SUPERIORES (J E J1)

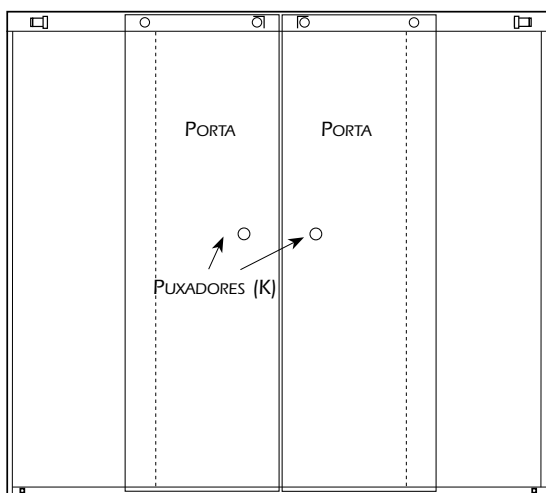

CONJUNTOS BATEDEIRAS INFERIORES (L)

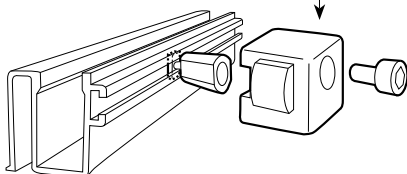

- 15 DETERMINAR AS MEDIDAS, CORTAR E ENCAIXAR OS PERFIS ARREMATE (D) NOS CANAIS DOS PERFIS TRILHO (A) E GUIA (C). ENCAIXAR A ESCOVA DE VEDAÇÃO (G) NO PERFIL GUIA (C)

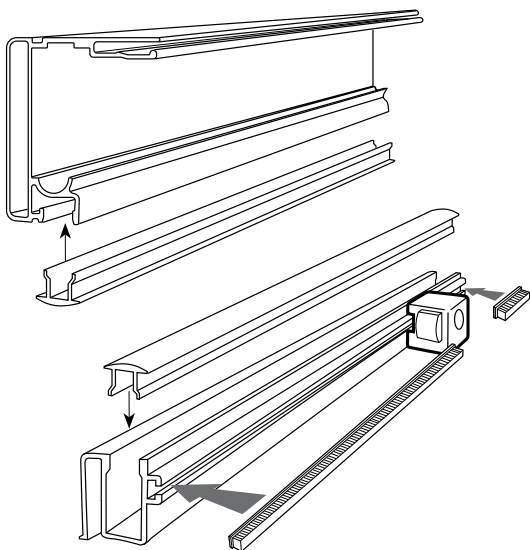

- 16 DETERMINAR AS MEDIDAS, CORTAR E ENCAIXAR O PERFIL CAPA (B) NO PERFIL TRILHO (A) E REBITAR

FUROS P/ REBITE (N) (3,5MM)

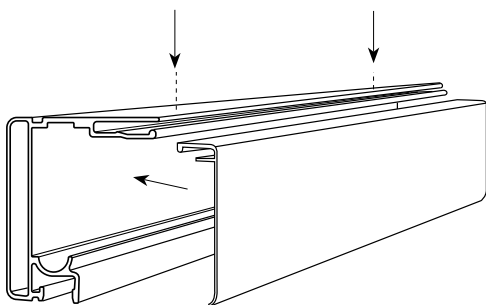

IMPORTANTE: PARA GARANTIR A SEGURANÇA DO PRODUTO INSTALADO, É OBRIGATÓRIO A REBITAGEM DA CAPA!

- 17 COLOCAR A ESCOVA DE VEDAÇÃO (G) NO PERFIL "H" DE VEDAÇÃO (F), CORTAR NA MEDIDA CORRETA E ENCAIXAR NA PORTA

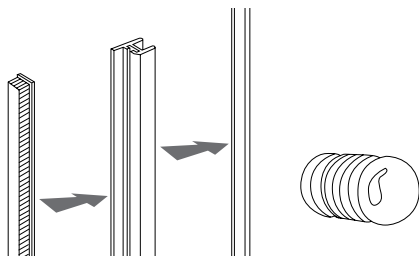

- 18 VEDAR TODA A PERIFERIA INTERNA ENTRE PERFIS E AZULEJO. UTILIZAR SILICONE ANTIFUNGO

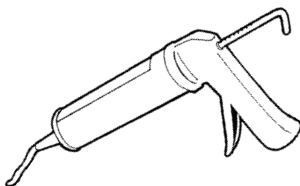

2 FIXOS E 2 PORTAS













C1/MC1



IMAGEM ILUSTRATIVA



ITEM	QUANT.	DESCRIÇÃO	DESENHO
A	01	PERFIL TRILHO	
B	01	PERFIL CAPA	
C	01	PERFIL GUIA	
D	01	PERFIL ARREMATE	
E	02	PERFIL "U" 20x10	
F	01	PERFIL "H" VEDAÇÃO	
G	01	ESCOVA DE VEDAÇÃO	
H	02	SUPORE FIXAÇÃO TRILHO	
I	02	CUNHA TRAVA DO SUPORTE	
J	01	JUNÇÃO DO TRILHO	
K	02	PUXADOR	
L	02	CONJUNTO BATEDEIRA INFERIOR	
M	02	GUIA NYLON	
N	02	BATEDEIRA SUPERIOR LATERAL	

ITEM	QUANT.	DESCRIÇÃO	DESENHO
N1	02	BATEDEIRA SUPERIOR CENTRAL	
O	01	JUNÇÃO DA GUIA	
P	16	REBITE "POP"	
Q	04	ROLDANA	
R	06	PARAFUSO CABEÇA PANELA Ø 3,9x32MM	
S	06	BUCHA 6MM	
T	04	CUNHA REGULAGEM	
U	04	PARAFUSO CABEÇA CHATA Ø 3,5x22MM	
V	04	BUCHA 5MM	
W	02	ARREMATE DO TRILHO	
X	02	PARAFUSO CABEÇA PANELA Ø 3,5x13MM	
Z	01	ARREMATE DA CAPA	

OBS.: OS ELEMENTOS DE FIXAÇÃO (R, S, U E V)
SÃO PARA USO EM ALVENARIA

AS IMAGENS DE CONTEÚDO PODEM SOFRER ALTERAÇÕES
DE DESENHO CONFORME MODELO UTILIZADO

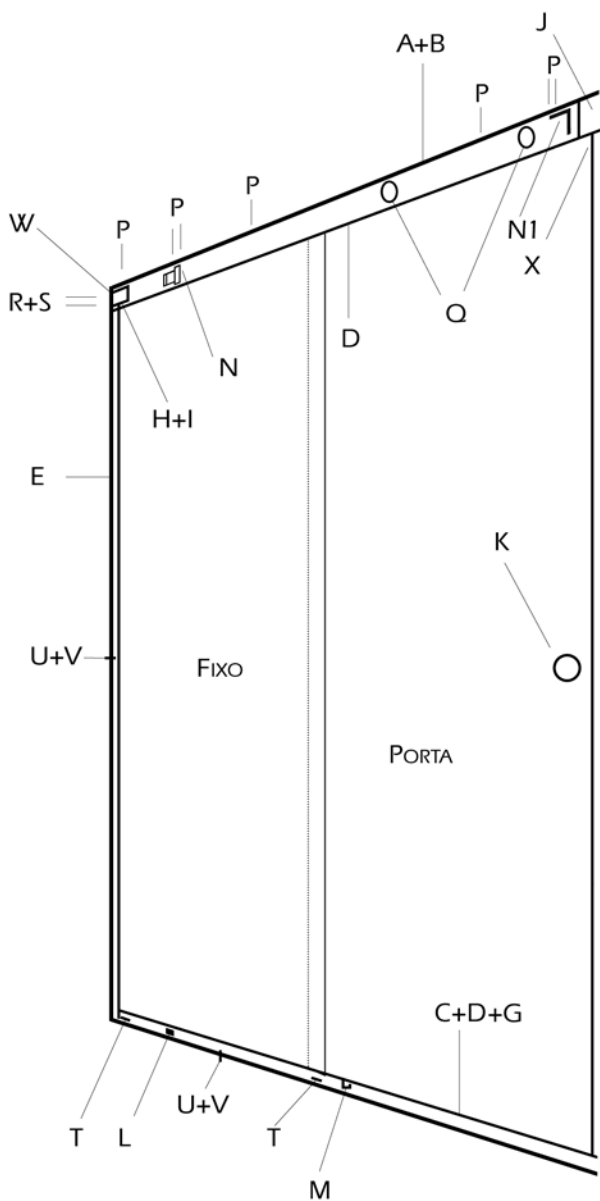

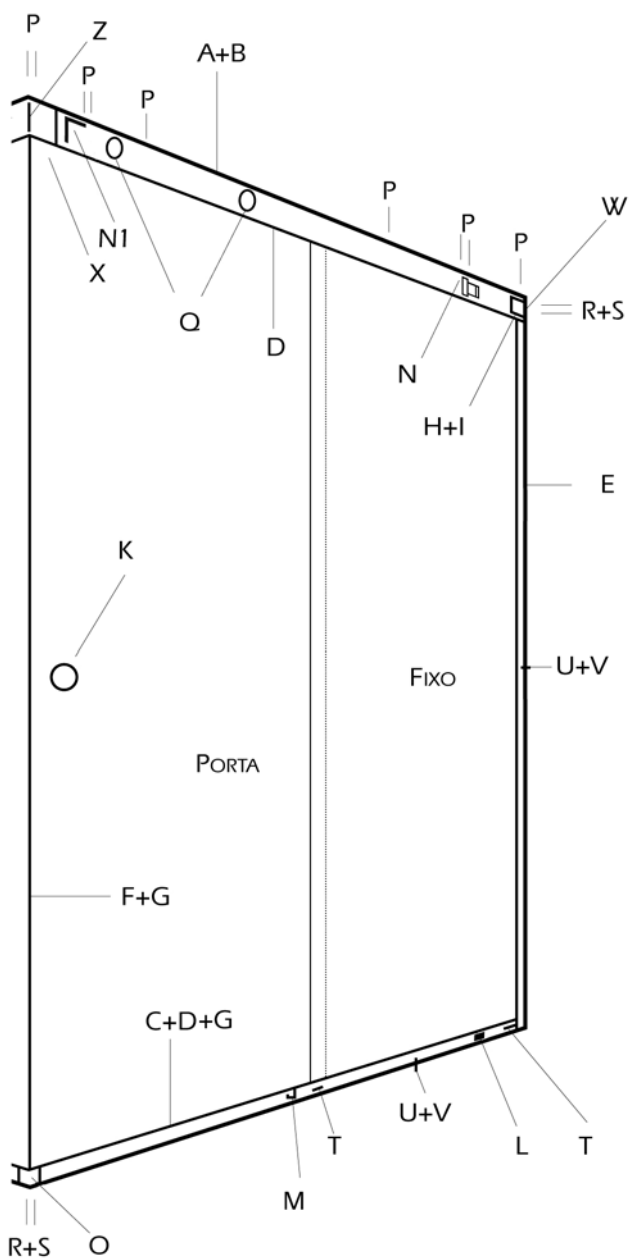

- 01** POSICIONAR E FIXAR OS PERFIS GUIA (C) E A JUNÇÃO DA GUIA (O) DEVIDAMENTE ENCAIXADOS

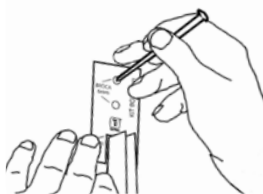
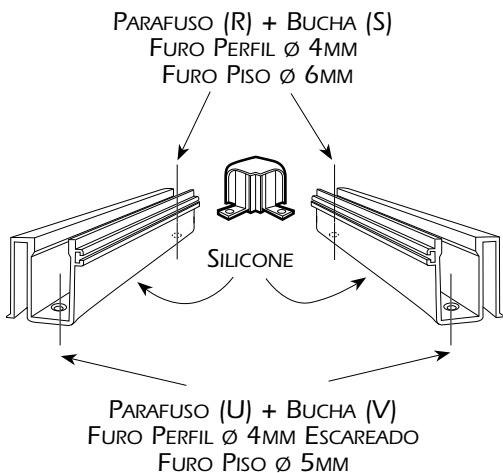

- 02** MARCAR OS FUROS DO SUPORTE DO TRILHO (H) USANDO O PERFIL "U" 20x10MM (E)

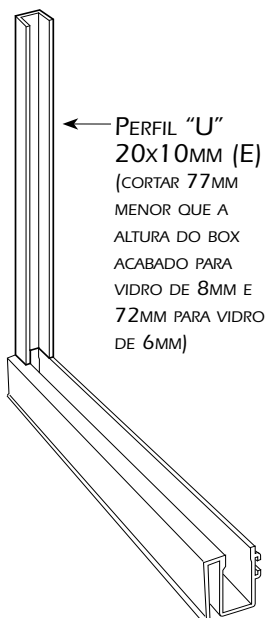

03 FIXAR OS PERFIS "U"
20x10MM (E)

FURO PERFIL (4MM)
FURO PAREDE (5MM)
PARAFUSO (U) + BUCHA (V)

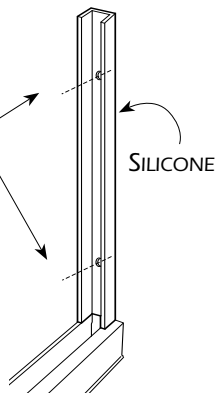

04 FIXAR OS SUPORTES
DO TRILHO (H)

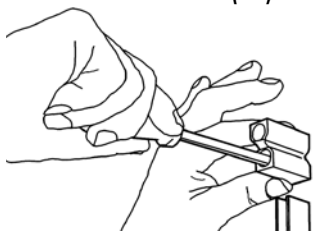

FURO PAREDE (6MM)
PARAFUSO (R) + BUCHA (S)

05 CORTAR OS PERFIS TRILHO (A) 4MM
MENOR E ENCAIXAR A JUNÇÃO SUPERIOR
(J) E OS ARREMATES (W) NAS
EXTREMIDADES

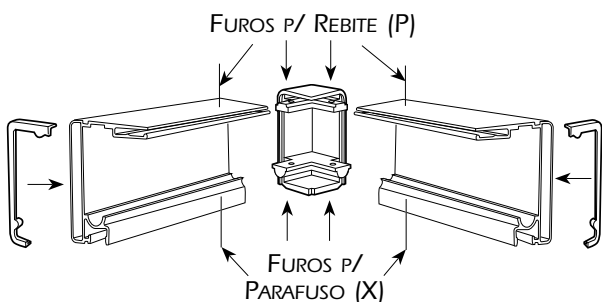

06 ENCAIXAR O
CONJUNTO
NOS SUPORTES
DOS TRILHOS (H),
TRAVAR COM A
CUNHA TRAVA DO
SUPORTE (I) E
REBITAR

FURO P/ REBITE (P) (3,5MM)

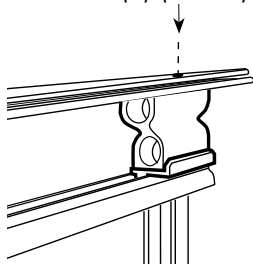

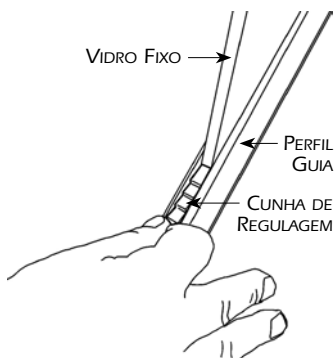
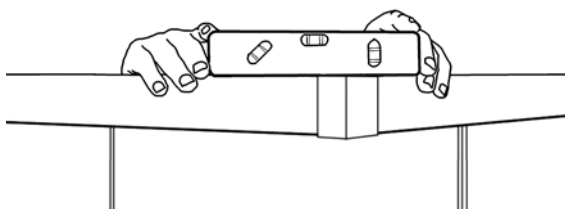
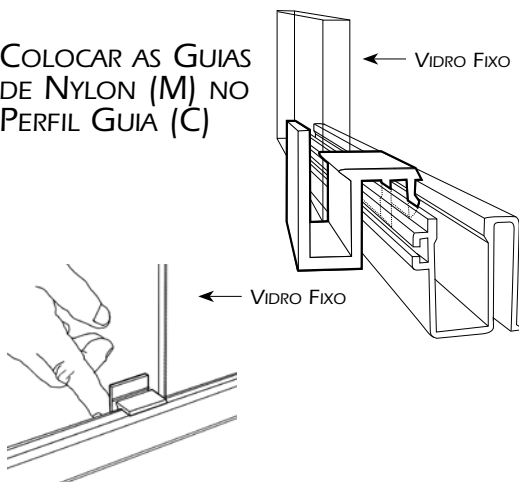
07 TRAVAR OS VIDROS FIXOS COM AS CUNHAS DE REGULAGEM (T)**08** VERIFICAR O NIVELAMENTO DO CONJUNTO**09** COLOCAR AS GUIAS DE NYLON (M) NO PERFIL GUIA (C)

- 10** MONTAR AS ROLDANAS (Q) E OS PUXADORES (K) NAS PORTAS

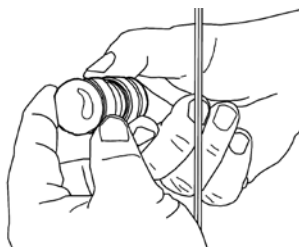
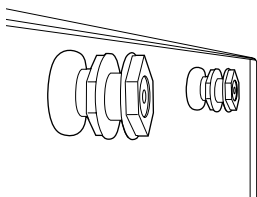

- 11** COLOCAR AS PORTAS MONTADAS NOS PERFIS TRILHO (A) E NAS GUIAS DE NYLON (S)

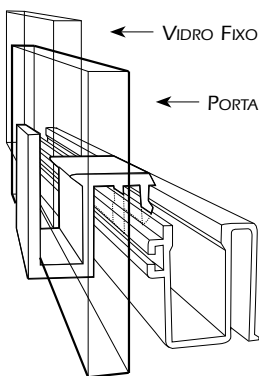

- 12** REGULAR AS PORTAS

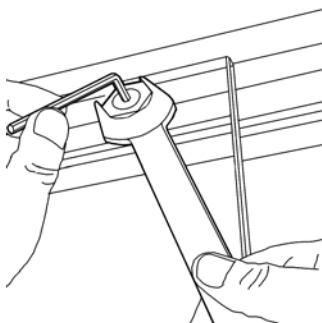

- 13** DETERMINAR A POSIÇÃO DE PARADA DAS PORTAS E FIXAR AS BATEDEIRAS LIMITADORAS SUPERIORES (N E N1) E INFERIORES (L)

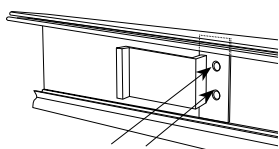

FUROS P/ REBITE (P)
(3,5MM)

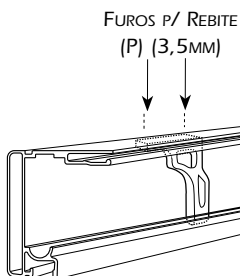

FUROS P/ REBITE
(P) (3,5MM)

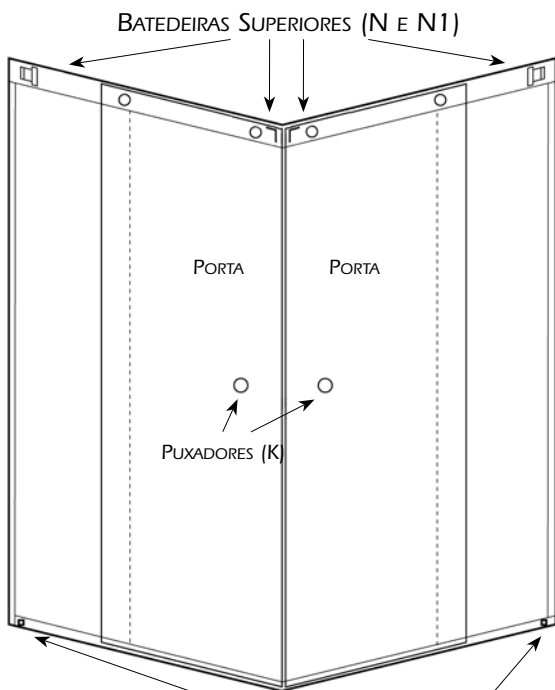

BATEDEIRAS SUPERIORES (N E N1)

PORTA

PORTA

PUXADORES (K)

CONJUNTOS BATEDEIRAS INFERIORES (L)

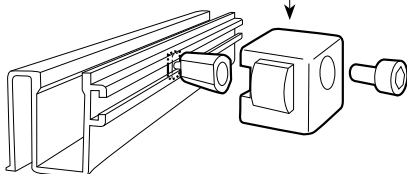

- 14 DETERMINAR AS MEDIDAS, CORTAR E ENCAIXAR OS PERFIS ARREMATE (D) NOS CANAIS DOS PERFIS TRILHO (A) E GUIA (C). ENCAIXAR AS ESCOVAS DE VEDAÇÃO (G) NO PERFIL GUIA (C)

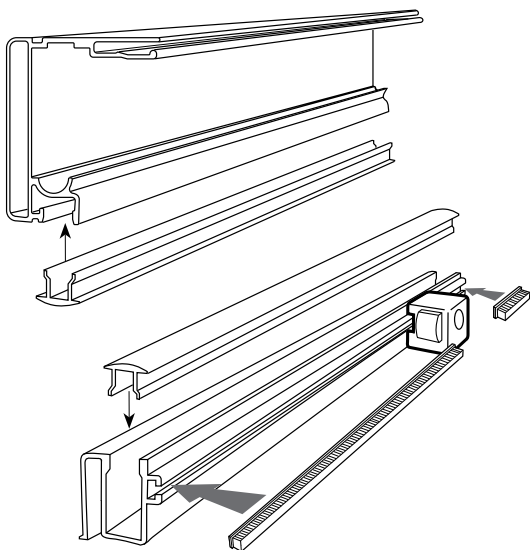

- 15 DETERMINAR AS MEDIDAS, CORTAR E ENCAIXAR O PERFIL CAPA (B) NO PERFIL TRILHO (A) E REBITAR

FUROS P/ REBITE (N) (3,5MM)

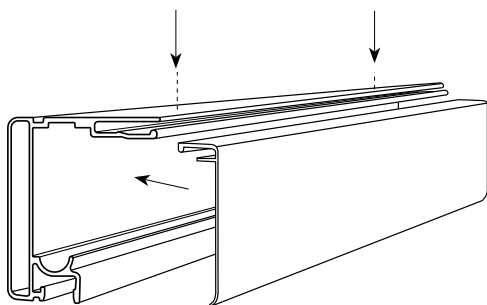

IMPORTANTE: PARA GARANTIR A SEGURANÇA DO PRODUTO INSTALADO, É OBRIGATÓRIO A REBITAGEM DA CAPA!

- 16 ENCAIXAR O ARREMATE DA CAPA (Z) NA UNIÃO DOS PERFIS CAPA (B) E REBITAR OS PERFIS CAPA (B) NOS PERFIS TRILHO (A)

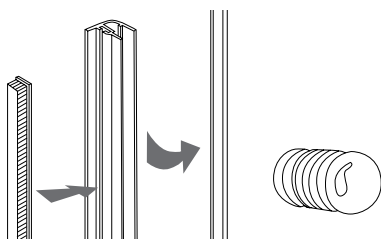
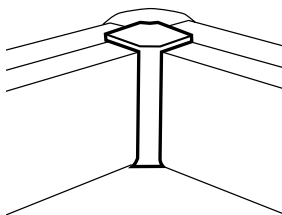

- 17 COLOCAR A ESCOVA DE VEDAÇÃO (G) NO PERFIL "H" DE VEDAÇÃO (F), CORTAR NA MEDIDA CORRETA E ENCAIXAR NA PORTA

- 18 VEDAR TODA A PERIFERIA INTERNA ENTRE PERFIS E AZULEJO. UTILIZAR SILICONE ANTIFUNGO

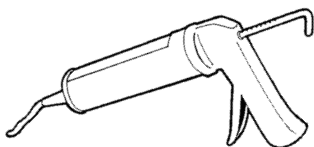

SEM TRANSPACE

AF/ST



IMAGEM ILUSTRATIVA



FURAÇÃO PARA DOBRADIÇAS

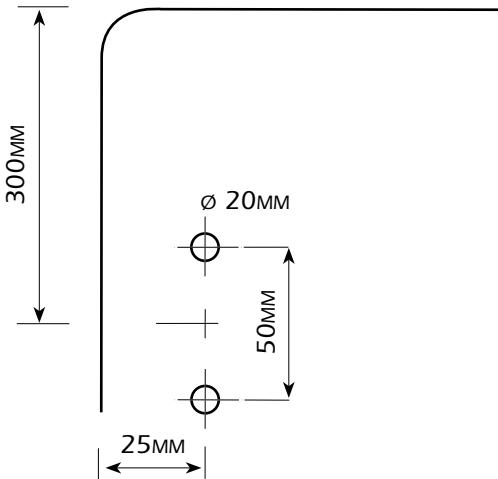

FURAÇÃO PARA PUXADOR

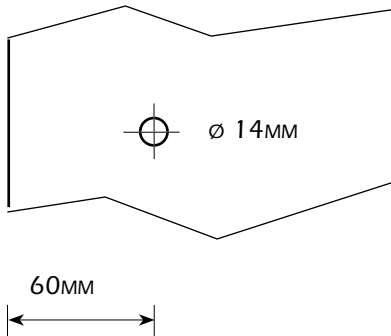

ITEM	QUANT.	DESCRIÇÃO	DESENHO
A	01	PERFIL GUIA DE ABRIR	
B	02	PERFIL "U" 20x10	
C	01	PERFIL "H" DE VEDAÇÃO	
D	04	PARAFUSO CABEÇA CHATA Ø 3,5x22MM	
E	04	BUCHA 5MM	
F	02	DOBRADIÇA 1114 (OPCIONAL)	
G	02	ESCOVA DE VEDAÇÃO	
H	01	PUXADOR	

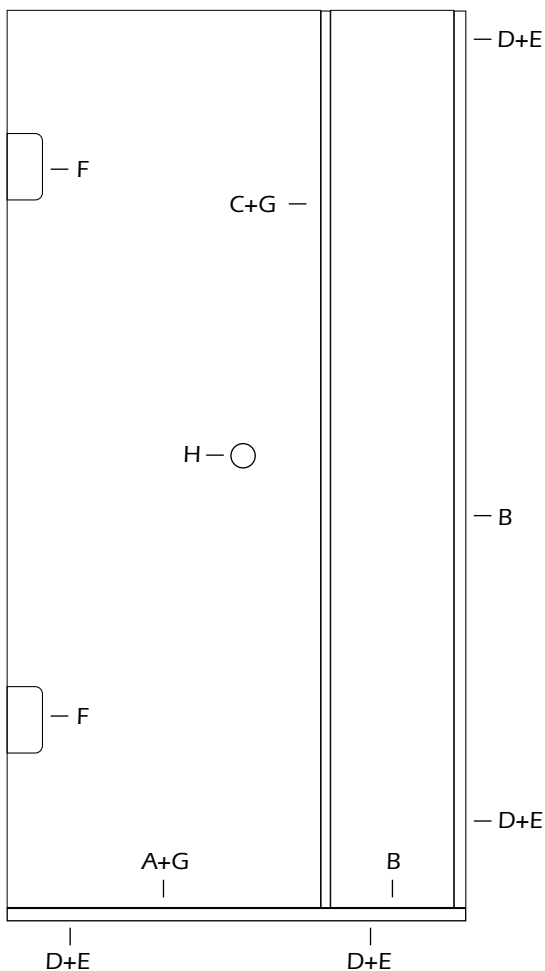

- 01** COLOQUE A ESCOVA DE VEDAÇÃO (G) NO PERFIL GUIA (A) E FIXE NO PISO JUNTO COM O PERFIL "U" (B)

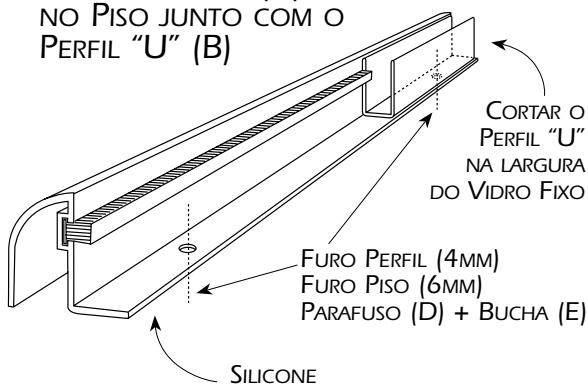

- 02** FIXE O PERFIL LATERAL (B)

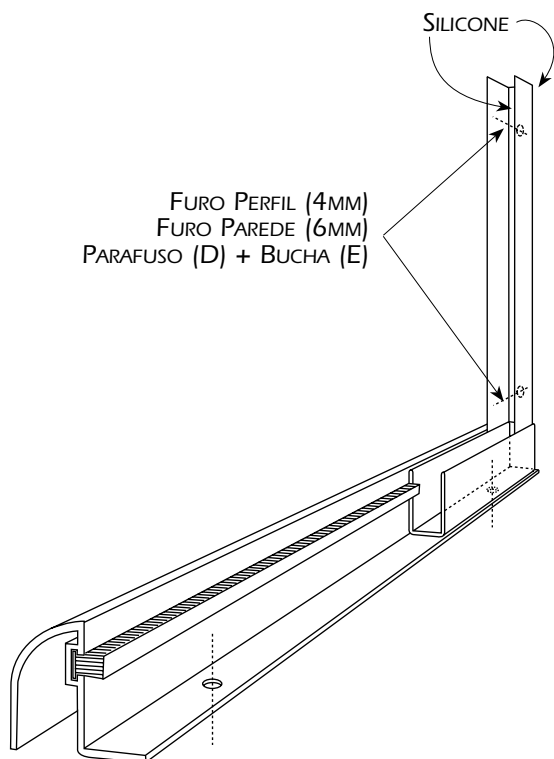

- 03 COLOQUE A ESCOVA DE VEDAÇÃO (G) NO PERFIL "H" (C) E ENCAIXE NO VIDRO FIXO

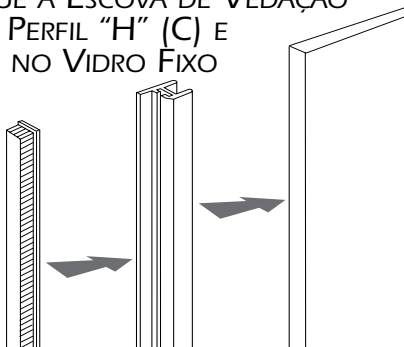

- 04 ENCAIXE O VIDRO FIXO NO PERFIL LATERAL (B)

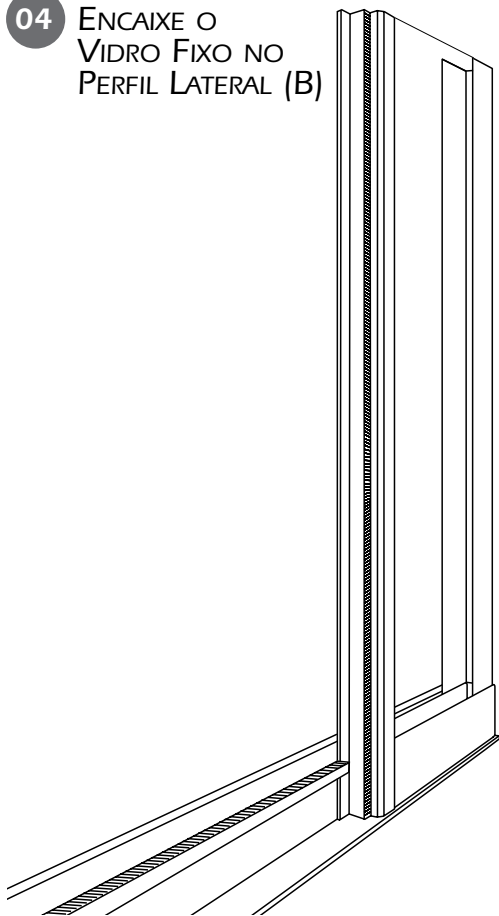

05 MONTE A DOBRADIÇA (F) E O PUXADOR (H) NA PORTA

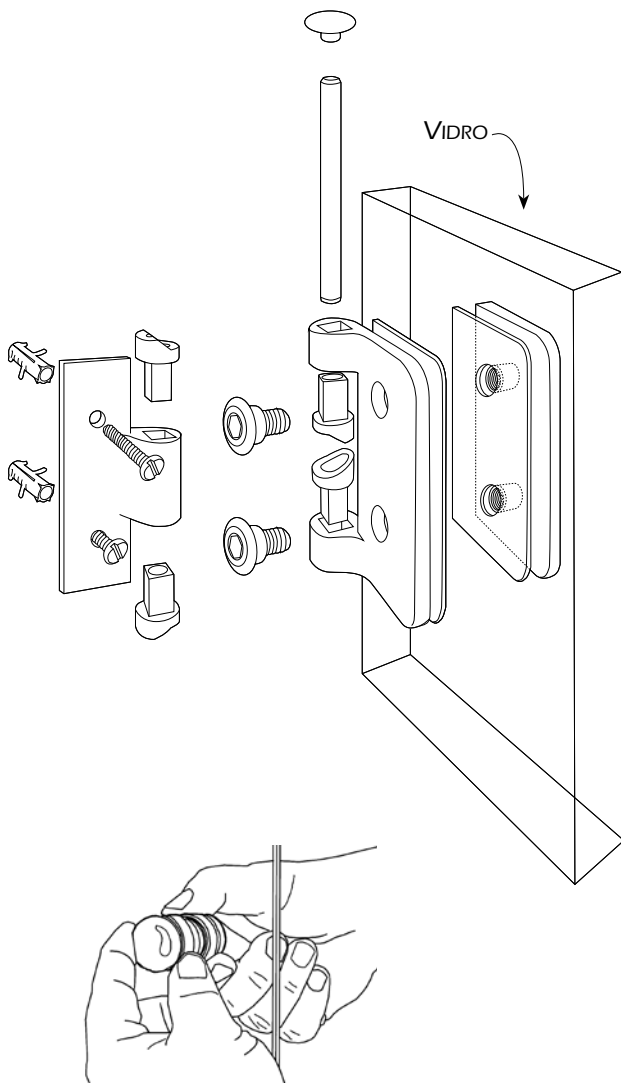

06 FIXE A PORTA NA PAREDE

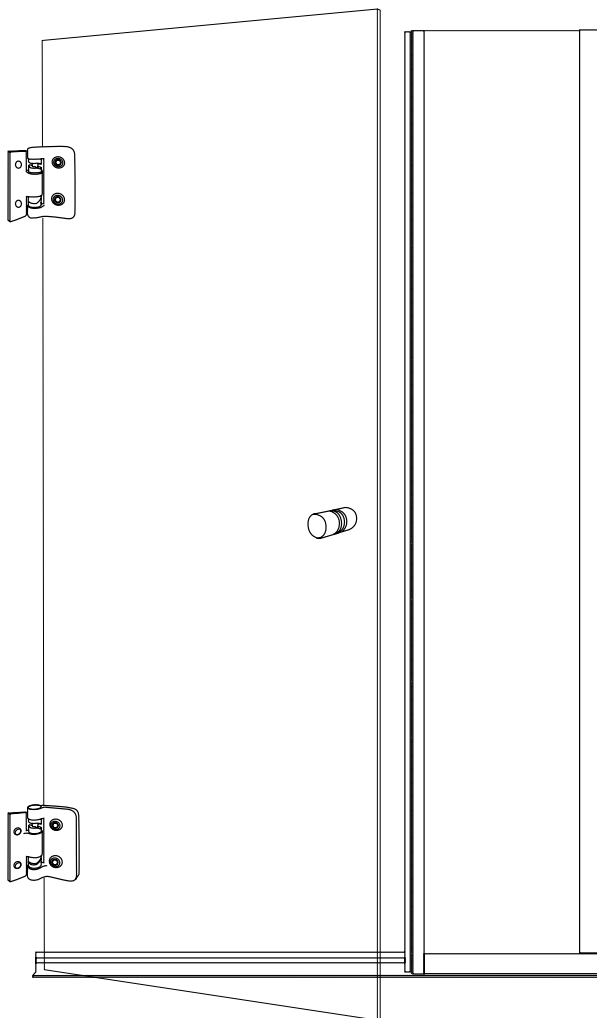

COM TRANSPACE
AF/CT



IMAGEM ILUSTRATIVA



ITEM	QUANT.	DESCRIÇÃO	DESENHO
A	01	PERFIL GUIA	
B	01	PERFIL "U" 20x10	
C	01	PERFIL "U" DE VEDAÇÃO	
D	01	Perfil ARREMATE	
E	04	PARAFUSO CABEÇA CHATA 3,5X22	
F	04	BUCHA 5MM	
G	02	DOBRADIÇA 1114 (OPCIONAL)	
H	02	ESCOVA DE VEDAÇÃO	
I	01	PUXADOR	

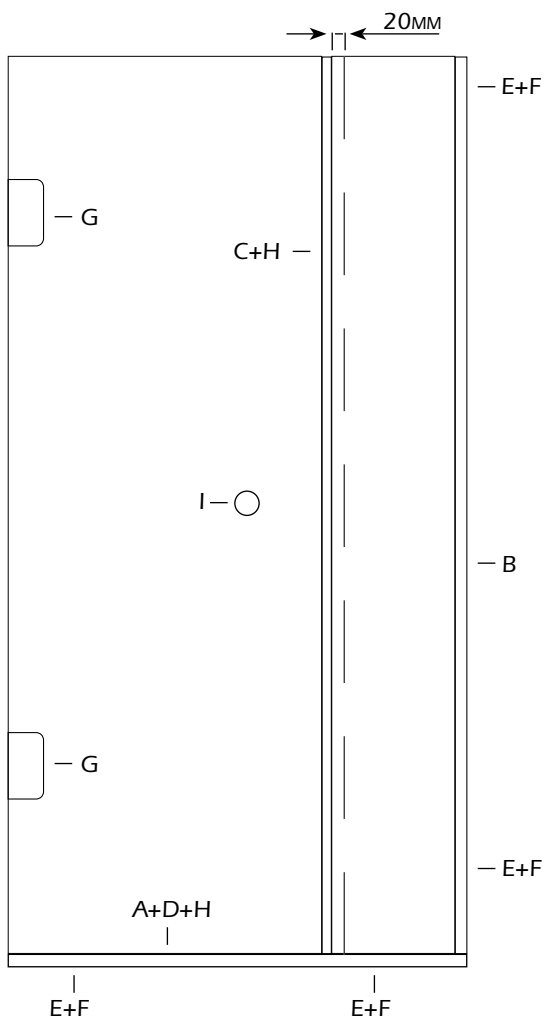

- 01 COLOQUE A ESCOVA DE VEDAÇÃO (H) NO PERFIL GUIA (A) E FIXE NO PISO

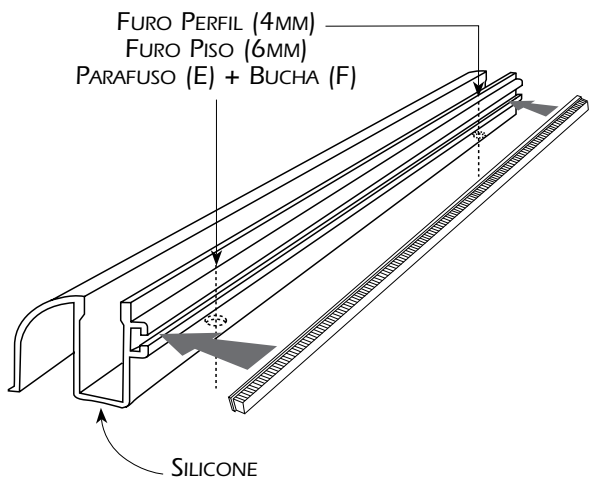

- 02 FIXE O PERFIL LATERAL (B)

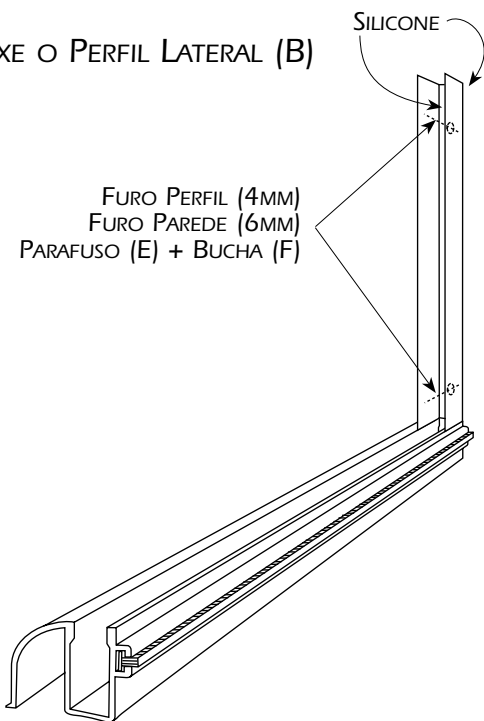

- 03** COLOQUE A ESCOVA (H) NO PERFIL "U" DE VEDAÇÃO (C) E ENCAIXE NO VIDRO FIXO

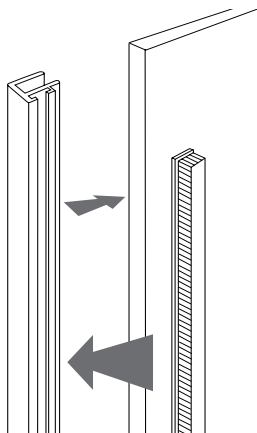

- 04** ENCAIXE O VIDRO FIXO NO PERFIL LATERAL (B) E NO PERFIL GUIA (A) E COLOQUE O PERFIL ARREIMATE (D)

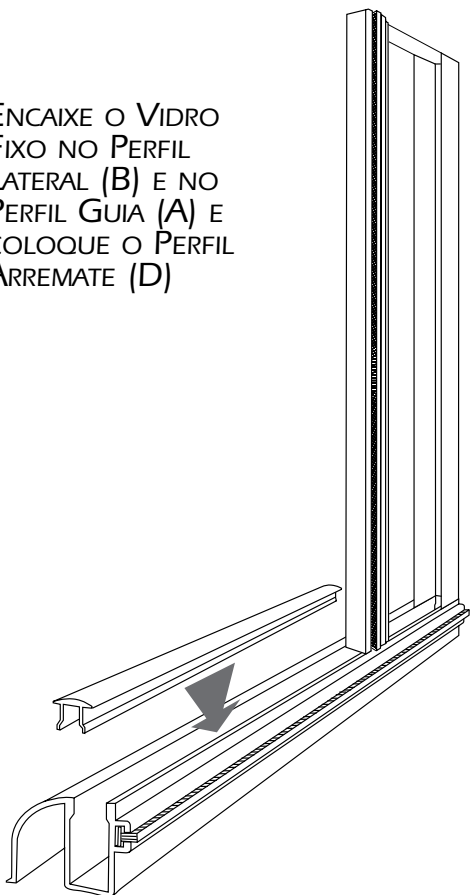

- 05 MONTE A DOBRADIÇA (G) E O PUXADOR (I) NA PORTA

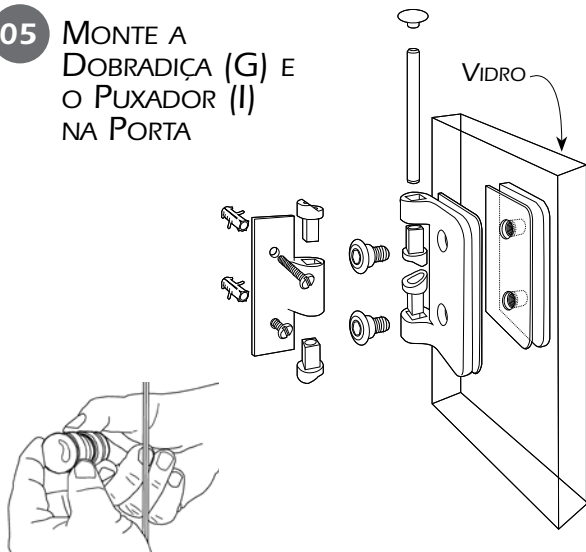

- 06 FIXE A PORTA NA PAREDE

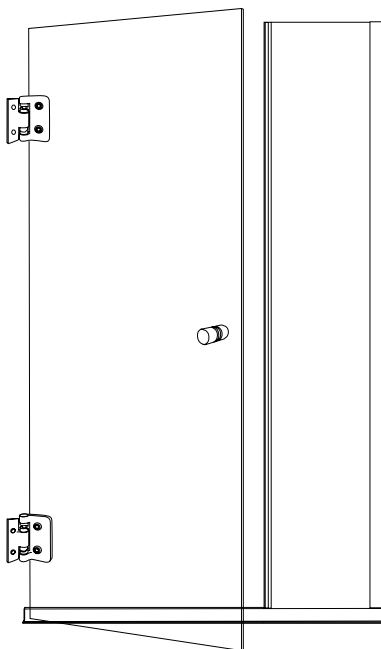



- Kits para Box, Janelas e Engenharia
- Roldanas
- Perfis e acessórios para vidro temperado

Rua 7 de Julho, 32 - Socorro
CEP 04760-070 - São Paulo - SP

Tel.: (11) 5682-2366 - Fax: (11) 5682-2360

tecvidro@tecvidro.com.br - www.tecvidro.com.br

