

**SPEED
TEMPER**



Uma empresa vidrada em você!

BOX FRONTAL



IMAGEM ILUSTRATIVA

BOX FRONTAL 06 E 08MM

1 PORTA E 1 FIXO

MANUAL DE MONTAGEM KIT BOX 06MM

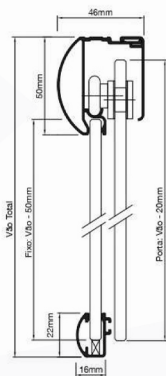

MANUAL DE MONTAGEM KIT BOX 08MM

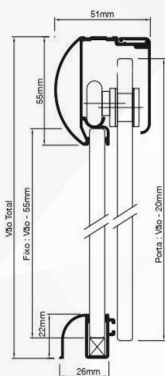

FURAÇÃO PARA ROLDANAS

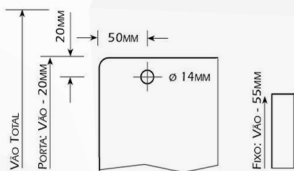

PERFIL GUIA

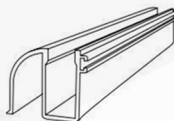

08mm

FURAÇÃO PARA PUXADOR

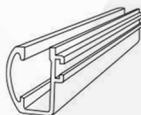
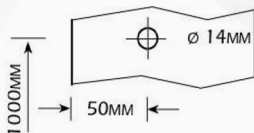

06mm

FERRAMENTAS PARA INSTALAÇÃO

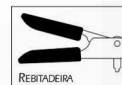
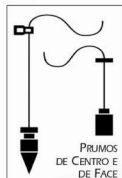
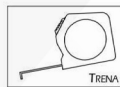
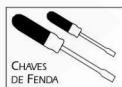
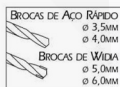

MONTAGEM

1. MONTAGEM PERFIL GUIA (C)

FURO PERFIL (4MM)
FURO PISO (5MM)
PARAFUSO (R) + BUCHA (S)

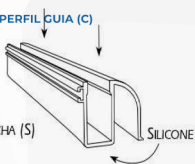

3. FIXAR PERFIL "U" 20X10 MM (E) COM BUCHAS (S) + PARAFUSO (R)



2. MARCAR OS FUROS DO SUPORTE DO TRILHO (G) USANDO O PERFIL "U" 20X10MM (E)

PERFIL "U" 20X10MM (E)
(CORTEIR 77MM MENOR QUE A ALTURA DO BOX ACABADO PARA VIDRO DE 8MM E 72MM PARA VIDRO DE 6MM)



4. FIXAR OS SUPORTES DO TRILHO (G)

FURO PAREDE (6MM)
PARAFUSO (P) + BUCHA (C)



5. CORTAR O PERFIL TRILHO (A) 4MM MENOR QUE O VÃO E ENCAIXAR OS ARREMATES (U) NAS EXTREMIDADES



7. TRAVAR O CONJUNTO COM A CUNHA TRAVA DO SUPORTE (H) E REBITAR

FUROS P/ REBITE (N) (3.5MM)

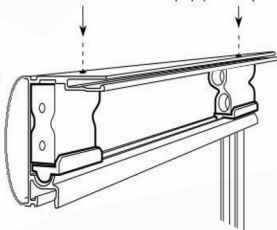

8. TRAVAR O VIDRO FIXO COM A CUNHA DE REGULAGEM (T)

VIDRO FIXO

PERFIL GUIA
CUNHA DE REGULAGEM



9. VERIFICAR O NIVELAMENTO DO CONJUNTO



10. COLOCAR A GUIA DE NYLON (J) NO PERFIL GUIA (C)

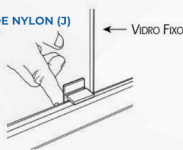

11. MONTAR AS ROLDANAS (O) E O PUXADOR (M) NA PORTA



13. REGULAR A PORTA

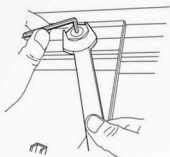

15. DETERMINAR A POSIÇÃO DA PARADA DA PORTA E FIXAR A BATEDEIRA LIMITADORA SUPERIOR (K) E INFERIOR (I)

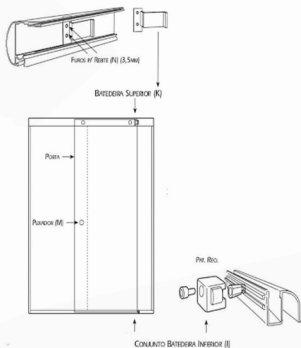

12. COLOCAR A PORTA MONTADA NO PERFIL TRILHO (A) E NA GUIA DE NYLON (J)

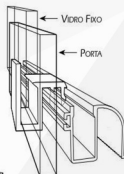

14. INSTALAR O PERFIL "U" 20X15 (F) COM BUCHAS (S) + PARAFUSO (R)

FURO PERFIL (4MM)
FURO PAREDE (5MM)

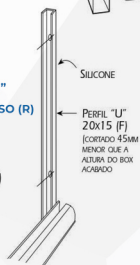

16. DETERMINAR AS MEDIDAS, CORTAR E ENCAIXAR OS PERFIS ARREIMATE (D) NOS CANAIS DOS PERFIS TRILHO (A) E GUIA (C). ENCAIXAR A ESCOVA DE VEDAÇÃO (V) NO PERFIL GUIA (C)

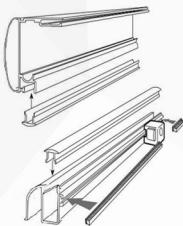

17. DETERMINAR AS MEDIDAS, CORTAR E ENCAIXAR O PERFIL CAPA (B) NO PERFIL TRILHO (A) E REBITAR

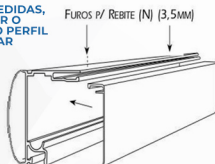

CONTEÚDO

ITEM	QUANT.	DESCRIÇÃO	DESENHO
A	01	PERFIL TRILHO	
B	01	PERFIL CAPA	
C	01	PERFIL GUIA	
D	01	PERFIL ARREMATE	
E	01	PERFIL "U" 20X10	
F	01	PERFIL "U" 20X15	
G	02	SUPORTE FIXAÇÃO TRILHO	
H	02	CUNHA TRAVA DO SUPORTE	
I	01	CONJUNTO BATEDEIRA INFERIOR	
J	01	GUIA NYLON	
K	01	BATEDEIRA SUPERIOR	
L	02	BATEDEIRA AMORTECEDORA	
M	01	PUXADOR	

ITEM	QUANT.	DESCRIÇÃO	DESENHO
N	06	REBITE "POP"	
O	02	ROLDANA	
P	04	PARAFUSO CABEÇA PAINELA Ø 3,9X32MM	
Q	04	BUCHA 6MM	
R	04	PARAFUSO CABEÇA CHATA Ø 3,5X22MM	
S	04	BUCHA 5MM	
T	02	CUNHA REGULAGEM	
U	02	ARREMATE DO TRILHO	
V	01	ESCOVA DE VEDAÇÃO	
OBS.: OS ELEMENTOS DE FIXAÇÃO (P, Q, R E S) SÃO PARA USO EM ALVENARIA			
AS IMAGENS DE CONTEÚDO PODEM SOFRER ALTERAÇÕES DE DESENHO CONFORME MODELO UTILIZADO			